

Mosa.

Product Details

Versie / Version 2026-01

Mosa.

Royal Mosa

Meerssenerweg 358
NL-6224 AL Maastricht
P.O. Box 1026
NL-6201 BA Maastricht

Algemeen / Réception / Allgemein / General

T +31 (0)43 368 94 44
info@mosa.com
www.mosa.com

Customer Service

T +31 (0)43 368 92 29
info@mosa.com

After Sales

T +31 (0)43 368 92 49
aftersales@mosa.com

Versie / Version 26-01

Dit Product Details-boek bevat informatie over producten die bij Koninklijke Mosa bv (Mosa) te koop zijn. Mosa heeft alle redelijke inspanningen geleverd om de nauwkeurigheid van de informatie te waarborgen en kan niet aansprakelijk worden gesteld voor mogelijke fouten. Mosa biedt geen garantie voor de nauwkeurigheid en behoudt zich het recht voor om zonder voorafgaande kennisgeving en op elk gewenst moment wijzigingen aan te brengen in zijn portfolio en prijzen. Houd er rekening mee dat deze documentatie geen exacte weergave van kleuren en structuren bevat vanwege technische beperkingen. Daarnaast kunnen de aangegeven verpakkingsgegevens afwijken van de daadwerkelijk geleverde hoeveelheden. Alle voorgaande edities van dit Product Details-boek worden vervangen en herroepen door deze nieuwe editie. Ga naar www.mosa.com voor een overzicht van ons meest recente productaanbod.

Ce livre Product Details comprend des informations sur les produits disponibles à l'achat auprès de Royal Mosa bv (Mosa). Mosa a fait tous les efforts raisonnables pour garantir l'exactitude des informations et ne peut en aucun cas être tenu responsable des erreurs éventuelles. Mosa ne garantit pas l'exactitude des données et se réserve le droit d'apporter des modifications à son portefeuille et à ses prix sans préavis et à tout moment. Veuillez noter que cette documentation ne comporte pas de reproduction exacte des couleurs et structures en raison de restrictions techniques. En outre, les détails d'emballage indiqués peuvent différer des quantités effectivement livrées. Toutes les éditions précédentes du livre Product Details sont remplacées et annulées par cette nouvelle édition. Pour un aperçu de notre offre de produits la plus récente, veuillez consulter le site www.mosa.com.

Dieses Product Details-Buch enthält Informationen zum verfügbaren Produktangebot von Royal Mosa bv (Mosa). Mosa hat alles unternommen, was nach vernünftigem Ermessen erforderlich ist, um die Genauigkeit der Informationen zu gewährleisten, und lehnt jegliche Haftung für eventuelle Fehler ab. Mosa garantiert nicht für die Genauigkeit und behält sich das Recht vor, ohne Vorankündigung jederzeit Änderungen am Produktsortiment und den Preisen vorzunehmen. Bitte beachten Sie, dass diese Dokumentation aufgrund technischer Einschränkungen keine exakte Wiedergabe der Farben und Strukturen darstellt. Ferner können die Verpackungsangaben von den tatsächlichen Liefermengen abweichen. Diese neue Ausgabe ersetzt alle vorherigen Ausgaben des Product Details-Buches. Eine Übersicht über unser aktuelles Produktangebot finden Sie unter www.mosa.com.

This Product Details book includes information about products available for purchase from Royal Mosa bv (Mosa). Mosa has made all reasonable efforts to ensure the accuracy of the information and cannot be held responsible for potential errors. Mosa does not warrant the accuracy and reserves the right to make changes to its portfolio and pricing without notice and at any time. Please note that this documentation does not include an exact reproduction of colours and structures due to technical restrictions. Moreover, the indicated packing details can differ from the actual delivered quantities. All preceding editions of this Product Details book are replaced and cancelled by this new edition. For an overview of our most recent product offering please visit www.mosa.com.

© Royal Mosa Maastricht 2023

General information	5
Mosa	6
Mosa Design Studios	7
Sustainability	8
Ultragres	10
Support	14
Icons & symbols	17
Wall tiles	23
Floor tiles	75
Holland 2050 prefab tegelpanelen (NL only)	183
Residential	201
General Conditions	211

Mosa.

General information

Mosa



Mosa is een toonaangevende tegelproducent, die zich vooral op de internationale architectuurmarkt richt. Design, functionaliteit, duurzaamheid en professionaliteit vormen de kern van dit bedrijf. Mosa heeft reeds méér dan 140 jaar ervaring in het vervaardigen van keramiek. Dankzij deze kennis kan het bedrijf unieke technologieën en apparatuur ontwikkelen voor de productie van breed toepasbare wand- en vloertegels. Het ontwerp- en productieproces vindt in eigen beheer plaats, zodat dit proces compact en flexibel blijft.

Mosa, leader dans la production de carreaux, est axé principalement sur le marché international de l'architecture. Design, fonctionnalité, durabilité et professionnalisme sont au cœur de l'activité de l'entreprise. Mosa dispose d'une expérience de plus de 140 années en matière de fabrication de céramique. Grâce à ces connaissances, l'entreprise est en mesure de développer des technologies et des équipements uniques pour la production de carreaux de sol et muraux offrant un large éventail d'applications. L'ensemble de la conception et de la production se fait en interne, garantissant ainsi l'homogénéité et la flexibilité du processus.

Mosa ist ein führender Fliesenhersteller, der sich in erster Linie auf den internationalen Architekturmarkt konzentriert. Design, Funktionalität, Nachhaltigkeit und Professionalität bilden das Herz unseres Unternehmens. Mosa verfügt über mehr als 140 Jahre Erfahrung in der Herstellung von Keramik. Dank dieses Know-how kann das Unternehmen einzigartige Technologien und Geräte für die Herstellung vielseitig einsetzbarer Wand- und Bodenfliesen entwickeln. Der Design- und Fertigungsprozess findet in unserem Unternehmen statt, was Kompaktheit und Flexibilität gewährleistet.

Mosa is a leading tile producer specialising in the international architecture market. Its core values are design, functionality, durability, and professionalism. Mosa has more than 140 years of experience in tile production, which has allowed the company to develop unique technologies and devices for the production of broadly applicable wall and floor tiles. The design and production processes take place in-house to ensure a both compact and flexible process.

Mosa Design Studios

Mosa Design Studios, showrooms speciaal ontworpen voor architecten en designers. De complete collectie van Mosa, gepresenteerd in een minimalistische, inspirerende omgeving. Plan uw tegelprojecten en verzamel de benodigde monsters en brochures. Contactgegevens van onze showrooms en onze dealers kunt u vinden op www.mosa.com.

Mosa Design Studios, des showrooms pour les architectes et les designers. La gamme complète de carreaux de Royal Mosa, présentée dans une atmosphère minimalisée et inspirée. Ici, vous pouvez planifier votre chantier de carreaux et, si souhaité, emmener des échantillons et brochures. Vous pouvez trouver les coordonnées de nos showrooms ainsi que celles de nos distributeurs sur www.mosa.com.

Mosa Design Studios, Showrooms für Architekten und Designer. Die vollständige Fliesenkollektion von Royal Mosa in einer inspirierenden, minimalistischen Atmosphäre. Planen Sie hier Ihr Fliesenprojekt und nehmen Sie, falls nötig, direkt Fliesenmuster und Broschüren mit. Für Kontaktdaten unseren Showrooms und die aktuelle Stützpunkthändlerliste siehe www.mosa.com.

Mosa Design Studios, dedicated showrooms for architects and designers. Royal Mosa's entire tile collection, presented in a minimalist but inspiring setting enabling you to plan your tiling projects and collect samples and brochures as required. Contact details of our showrooms as well as our distributors can be found on www.mosa.com.



Sustainability

Mosa en Cradle to Cradle

Duurzaamheid is één van de kernwaarden van Mosa. Mosa investeert voortdurend in het verder ontwikkelen van duurzame producten en productiemethoden voor de eigen wand- en vloertegelfabrieken in Maastricht, Nederland. Mosa produceert met behulp van duurzame energie en zoekt eco-effectieve oplossingen om de materialenkringloop te sluiten. Cradle to Cradle is een bekend concept op het gebied van duurzaamheid. De samenstelling van Mosa-tegels is puur en zuiver, geschikt voor behoud in de technische kringloop. Er komen dus geen schadelijke stoffen vrij tijdens en na de lange gebruiksduur. Daarom ontving Mosa voor nagenoeg de gehele collectie tegels als eerste tegelfabrikant ter wereld het Cradle to Cradle Certified® Gold-certificaat.

LCA, EPD en MRPI van Mosa-tegels

Mosa-tegels zijn chemisch inert en zeer slijtvast. Ze kennen daardoor een zeer lange technische levenscyclus. Technisch gezien kunnen Mosa-tegels honderden jaren meegaan en gedurende deze periode blijft hun uiterlijk en technische kwaliteit bij normaal gebruik als op de eerste dag. Mosa beschikt over een extern gevalideerde LCA (Levenscyclus Analyse), die het duurzame karakter ervan onderschrijft. De resultaten ervan zijn weergegeven in de EPD (Environmental Product Declaration) en MRPI (Milieu Relevante Product Informatie) voor wand- en vloertegels, die op aanvraag bij Mosa verkrijgbaar zijn via www.mosa.com

Mosa-tegels in duurzame gebouwen

Mosa is het eerste keramische tegelbedrijf ter wereld dat erin is geslaagd om bijna de gehele tegelcollectie Cradle to Cradle Certified® Gold te laten certificeren. De Cradle to Cradle-certificering wordt algemeen erkend en draagt bij aan positieve scores voor Nederlandse en internationale keurmerken voor duurzaam bouwen zoals LEED, DGNB, BREEAM, WELL en HQE. Bij de meeste van deze duurzame bouwkeurmerken zijn de categorieën ingedeeld in kredieten, waarvoor punten gescoord kunnen worden. Deze keurmerken zijn continu in ontwikkeling. Een actueel overzicht van de bijdrage van Mosa-tegels aan LEED, DGNB, BREEAM, WELL en HQE kan daarom worden gevonden op de duurzaamheidspagina's op www.mosa.com.

Mosa et Cradle to Cradle

Pour Mosa, le développement durable est l'une des valeurs fondamentales. Ce groupe ne cesse d'investir dans ce domaine, aussi bien au niveau de ses produits que de ses méthodes de production pour ses propres usines à Maastricht, Pays-Bas. Mosa a recours à de l'énergie propre pour sa production et est continuellement à la recherche de solutions éco-efficaces pour fermer les cycles de matériaux. Aucune substance nocive n'est libérée pendant leur durée d'utilisation. C'est la raison pour laquelle Mosa est le premier et le seul fabricant de carreaux au monde à avoir reçu la certification Cradle to Cradle Certified® Gold pour presque toute sa collection de carreaux.

Analyse du cycle de vie et Déclarations Environnementales carreaux Mosa

Chimiquement inertes, les carreaux Mosa sont très résistants à l'usure et se caractérisent donc par un cycle de vie technique extrêmement long. Techniquement parlant, les carreaux Mosa peuvent durer des centaines d'années et garder pendant toute cette période la même apparence et les mêmes qualités techniques qu'au premier jour, à condition bien sûr d'être utilisés dans des conditions normales. Mosa dispose d'une LCA (ou ACV, Analyse du Cycle de Vie) validée en externe, qui vient prouver le caractère durable de ses carreaux. Les résultats de cette analyse sont repris dans des EPD (Déclarations Environnementales de produits) pour faïences et carreaux de sol, disponibles sur demande chez Mosa à www.mosa.com.

Les carreaux Mosa dans des bâtiments durables

Mosa est la première entreprise de carrelage en céramique au monde à avoir réussi à faire certifier presque toute sa collection de carrelage Cradle to Cradle Certified® Gold. La certification Cradle to Cradle est largement reconnue et contribue à des scores positifs pour les labels de qualité néerlandais et internationaux pour la construction durable tels que LEED, DGNB, BREEAM, WELL et HQE. La plupart de ces labels de construction durable divisent les catégories en crédits pour lesquels des points peuvent être attribués. Ces labels de qualité sont en constante évolution. Un aperçu actualisé de la contribution des carreaux Mosa aux certifications LEED, DGNB, BREEAM, WELL et HQE est donc disponible sur les pages consacrées au développement durable sur www.mosa.com.



Mosa is lid van / Mosa est membre de / Mosa ist Mitglied von / Mosa is a member of:



Mosa and Cradle to Cradle

Nachhaltigkeit stellt bei Mosa einen der Kernwerte dar. Mosa investiert kontinuierlich in diesen Bereich für ihre eigenen Fabriken in Maastricht, die Niederlande, sowohl was die Produkte als auch das Fertigungsverfahren anbelangt. Die Produktion von Mosa findet auf der Grundlage nachhaltiger Energiequellen statt, und das Unternehmen ist immer wieder auf der Suche nach ökoeffektiven Lösungen um den Materialienkreislauf zu schließen. Cradle to Cradle ist ein renommiertes Nachhaltigkeitskonzept. Die keramischen Platten von Mosa besitzen eine hochreine Zusammensetzung, die für die Verwendung in den technischen Kreisläufen geeignet ist. So werden während und nach der langen Nutzungsdauer keine Schadstoffe freigesetzt. Deshalb wurde Mosa auch als weltweit erster Hersteller keramischer Platten mit dem Cradle to Cradle Certified® Gold-Zertifikat ausgezeichnet.

LCA und EPD Mosa-Fliesen

Mosa-Fliesen sind chemisch inert und besonders abriebfest, sodass sie einen sehr langen technischen Lebenszyklus aufweisen. In technischer Hinsicht können Mosa-Bodenfliesen Hunderte von Jahren verwendet werden, und in dieser Zeit bleiben ihr Aussehen und ihre technische Qualität bei normalem Gebrauch wie am ersten Tag. Mosa verfügt über eine extern geprüfte LCA (Lebenszyklusanalyse) durch die der nachhaltige Charakter bestätigt wird. Die Ergebnisse davon finden sich in den EPD (Umwelt-Deklaration) für Wand- und Bodenfliesen, die auf Wunsch bei Mosa erhältlich sind unter www.mosa.com.

Mosa-Fliesen in nachhaltigen Gebäuden

Mosa ist es als erstem Keramikfliesenunternehmen weltweit gelungen, nahezu seine gesamte Fliesenkollektion mit der Cradle to Cradle Certified® Gold-Zertifizierung zu versehen. Die Cradle to Cradle-Zertifizierung ist weithin anerkannt und trägt zu positiven Bewertungen bei niederländischen und internationalen Qualitätssiegeln für nachhaltiges Bauen wie LEED, DGNB, BREEAM, WELL und HQE bei. Die meisten dieser Labels für nachhaltiges Bauen unterteilen die Kategorien in Credits, für die Punkte vergeben werden können. Diese Gütezeichen werden kontinuierlich weiterentwickelt. Eine aktuelle Übersicht über den Beitrag der Mosa-Fliesen zu LEED, DGNB, BREEAM, WELL und HQE finden Sie daher auf den Nachhaltigkeitsseiten unter www.mosa.com.

Mosa and Cradle to Cradle

Sustainability is one of Mosa's core values. Mosa invests constantly in further development of sustainable products and production methods for its own wall and floor tile factories in Maastricht, the Netherlands. Mosa manufactures using sustainable energy and seeks eco-effective solutions to close the material cycles. Cradle to Cradle is a renowned sustainability concept. The composition of Mosa tiles has been developed to be free of contaminants and to use pure constituents, making them suitable for reuse in the technical cycles. No hazardous substances are released during or after their useful life. Therefore Mosa received, as the first tile manufacturer in the world, the Cradle to Cradle Certified® Gold certification.

LCA and EPD Mosa tiles

Mosa tiles are chemically inert and very durable. This means they have a very long technical life cycle. Mosa tiles can last for hundreds of years and during that period, with normal use, their appearance and technical quality will remain the same as on the first day they were fixed. Mosa has been granted an externally validated LCA (Life Cycle Analysis), which supports the sustainable nature of the tiles. The results can be found in the EPD (Environmental Product Declaration) for wall and floor tiles, available on request from Mosa at www.mosa.com.

Mosa tiles in sustainable buildings

Mosa is the first ceramic tile company in the world to have successfully achieved Cradle to Cradle Certified® Gold certification for almost its entire tile collection. Cradle to Cradle certification is widely recognized and contributes to positive scores for Dutch and international sustainable building quality marks such as LEED, DGNB, BREEAM, WELL and HQE. Most of these sustainable building quality marks consist of categories for which credits and points can be scored. These quality marks are continuously in development. An up-to-date overview of the contribution of Mosa tiles to LEED, DGNB, BREEAM, WELL and HQE can therefore be found on the sustainability pages at www.mosa.com.

Ultragres

Uitzonderlijke kwaliteit

Ultragres is het resultaat van meer dan 140 jaar ervaring, kennis, vakmanschap en passie voor keramiek. De superieure technische eigenschappen die de tegels kenmerken, zorgen voor goede prestaties op het gebied van maatvastheid, vlakheid, breuksterkte, buigsterkte en diepteslijtage. De normen die Mosa hanteert voor de prestaties van de tegels gaan verder dan de internationaal geldende productnormeringen. De tegels worden duurzaam geproduceerd en hebben een eigentijdse uitstraling. Het originele karakter van de tegels blijft tijdens de gehele levensduur behouden en kwaliteit en esthetiek zijn dan ook gegarandeerd. Dit alles maakt Ultragres-tegels een zekerheid op het gebied van toepasbaarheid, duurzaamheid en design.

Probleemloze toepasbaarheid

Ultragres maakt unieke toepassingen op het gebied van esthetiek en functionaliteit mogelijk. Voornamelijk kenmerken zijn de hoge belastbaarheid, de krasbestandheid, de loopveiligheid, het onderhoudsgemak en de lange levensduur. Doordat de tegels bestand zijn tegen zware belasting, is de oorspronkelijke uitstraling van het ontwerp gegarandeerd. Ultragres-tegels zijn dan ook uitermate geschikt voor omgevingen die zeer intensief worden gebruikt, zoals vliegvelden en treinstations. De passende antislip-eigenschappen van vloertegels maken Ultragres een geschikte keuze in ruimtes waar veiligheid een grote rol speelt, zoals douches en zwembaden. Zelfs zeer hoge mechanische en chemische belasting heeft geen effect op de kwaliteit van de tegels. De tegels zijn goed bestand tegen verontreiniging en vuilaanhechting. De reinigings-, onderhouds- en vervangingsfrequentie ligt dan ook zeer laag.

Een duurzame keuze

Mosa is het enige tegelbedrijf ter wereld met een Cradle to Cradle Certified® Gold-certificaat. De certificering is ook van toepassing op Ultragres. De tegels bestaan voornamelijk uit de natuurlijke grondstoffen klei en zand. Tijdens het productieproces vindt er continue kwaliteitscontrole plaats en de materiaalkringloop in de fabrieken is nagenoeg gesloten. Bovendien stoten de tegels geen schadelijke stoffen uit; ze dragen bij aan een gezond binnenklimaat en kunnen na gebruik veilig worden verwijderd. Cradle to Cradle-certificering draagt bij aan positieve scores voor diverse Nederlandse en internationale keurmerken voor duurzaam bouwen, waaronder BREEAM NL, LEED, DGNB en HQE. Daarbij zijn Ultragres-tegels door de uitzonderlijk goede eigenschappen amper onderhevig aan slijtage. Hierdoor is de kwaliteit gedurende de lange levensduur gegarandeerd. Dit alles maakt de tegels een zeer duurzame en verantwoorde keuze.

Elk gewenst design

De unieke eigenschappen van Ultragres zorgen ervoor dat ideeën werkelijkheid worden én blijven. Doordat Mosa haar dessins en tegelkleuren zelf ontwikkelt, kan elke gewenste signatuur en identiteit worden gecreëerd. Voor de bepaling van het kleuren- en structuren-assortiment onderhoudt Mosa een intensief contact met de markt en worden continue nieuwe creaties tot stand gebracht. De tegels zijn modulair waardoor voegen van wand en vloer op elkaar aansluiten. Dankzij deze eigenschap en de maatvastheid van de tegels kan een strakke en luxe uitstraling worden gecreëerd. Tegels van verschillende kleuren kunnen makkelijk door elkaar worden gebruikt en ook is het mogelijk om complexe patronen met smalle voegen op te nemen in het design.

Kortom, met Ultragres zijn kwaliteit in toepasbaarheid, duurzaamheid en design gedurende de hele levensduur gegarandeerd.



Une qualité exceptionnelle

Ultragres est le résultat de plus de 140 années d'expérience, de connaissance, de professionnalisme et de passion pour la céramique. Les caractéristiques techniques supérieures qui caractérisent les carreaux garantissent de bonnes performances en termes de stabilité dimensionnelle, de planéité, de charge de rupture, de résistance à la flexion et de résistance à l'abrasion. Les normes appliquées par Mosa pour les performances des carreaux vont plus loin que les normes de produits en vigueur au niveau international. Les carreaux sont produits durablement et ont un aspect moderne. Le caractère original des carreaux est conservé pendant toute leur durée de vie, garantissant le maintien de la qualité et de l'esthétique. Tout cela fait des carreaux Ultragres des produits sûrs en termes d'utilisation, de durabilité et de design.

Utilisation sans aucun problème

Ultragres permet des utilisations uniques en matière d'esthétique et de fonctionnalité. Les principales caractéristiques sont la capacité de charge élevée, la résistance aux rayures, l'antidérapance, la facilité d'entretien et une longue durée de vie. Puisque les carreaux résistent aux charges lourdes, l'aspect d'origine du concept est garanti. Les carreaux Ultragres conviennent par conséquent parfaitement aux environnements à très forte fréquentation, comme les aéroports et les gares ferroviaires. Les caractéristiques d'antidérapance appropriées des carrelages font d'Ultragres le choix idéal pour les espaces où la sécurité joue un rôle important, comme les douches et les piscines. Même une charge mécanique et chimique très élevée n'a aucun effet sur la qualité des carreaux. Ceux-ci résistent parfaitement à la pollution et à l'encrassement et nécessitent des nettoyages, entretiens et remplacements peu fréquents.

Un choix durable

Mosa est le seul fabricant de carrelages au monde à posséder un certificat Cradle to Cradle Certified® Gold. La certification s'applique également aux carreaux Ultragres. Les carreaux se composent principalement de matières premières naturelles, notamment de l'argile et du sable. Pendant le processus de fabrication, un contrôle de qualité a lieu en continu et le circuit des matériaux dans les usines est quasiment fermé. Les carreaux n'émettent en outre pas de substances nocives ; ils contribuent à un climat intérieur sain et peuvent, après usage, être éliminés en toute sécurité. La certification Cradle to Cradle contribue aux bons résultats à l'égard de différents labels de construction durable néerlandais et internationaux, dont BREEAM NL, LEED, DGNB et HQE. Les carreaux Ultragres ont à cet effet fait preuve de caractéristiques particulièrement bonnes, subissant à peine l'usure. La qualité est ainsi garantie pendant toute leur durée de vie prolongée. Cela fait de ces carreaux un choix particulièrement durable et responsable.

Chaque design souhaité

Les caractéristiques uniques d'Ultragres permettent aux idées de devenir et de rester une réalité. Étant donné que Mosa crée elle-même ses dessins et ses couleurs de carreaux, chaque signature ou identité souhaitée peut être créée. Pour définir l'assortiment de couleurs et de structures, Mosa reste continuellement en contact avec le marché et de nouvelles créations voient sans cesse le jour. Les carreaux sont modulables, permettant d'avoir des joints qui s'harmonisent parfaitement entre les murs et les sols. Grâce à cette caractéristique et à la stabilité dimensionnelle des carreaux, il est possible de créer une apparence sobre et luxueuse. Les carreaux de différentes couleurs peuvent facilement être mélangés entre eux et il est également possible d'inclure des modèles complexes avec des joints fins.

En bref, avec Ultragres, la qualité en termes d'utilisation, de durabilité et de design est garantie pendant toute la durée de vie.

Überragende Qualität

Ultragres ist das Resultat von über 140 Jahren Erfahrung, Wissen, Handwerk und Leidenschaft für Keramik. Die herausragenden technischen Eigenschaften, welche diese Fliesen auszeichnen, sorgen für optimale Leistungen im Hinblick auf Maßhaltigkeit, Ebenheit, Bruch- und Biegefestigkeit sowie Tiefenverschleiß. Die Normen von Mosa für die Eigenschaften der Fliesen gehen über die international geltenden Produktnormen hinaus. Die Fliesen werden nachhaltig hergestellt und haben eine moderne Ausstrahlung. Der ursprüngliche Charakter und die Optik der Fliesen bleiben während der gesamten Lebensdauer erhalten, was auch die Qualität und die Ästhetik gewährleistet. Daher sind Ultragres-Fliesen im Hinblick auf Anwendbarkeit, Nachhaltigkeit und Design absolut zuverlässig.

Problemlose Anwendbarkeit

Ultragres ermöglicht einzigartige Anwendungen im Bereich Ästhetik und Funktionalität. Wichtigste Eigenschaften sind die hohe Belastbarkeit, die Kratzbeständigkeit, die Begehsicherheit, die Pflegeleichtigkeit und die lange Lebensdauer. Da die Fliesen gegen hohe Belastungen widerstandsfähig sind, bleibt die ursprüngliche Ausstrahlung des Designs erhalten. Ultragres-Fliesen eignen sich daher bestens für Umgebungen, die sehr intensiv genutzt werden, zum Beispiel Flughäfen und Bahnhöfe. Die entsprechenden rutschhemmenden Eigenschaften von Fußbodenfliesen machen Ultragres-Fliesen zur optimalen Wahl für Räume, in denen Sicherheit eine große Rolle spielt, zum Beispiel Duschen und Schwimmbäder. Selbst sehr hohe mechanische und chemische Belastungen haben keinen Effekt auf die Qualität und Optik der Fliesen. Die Fliesen bieten eine hohe Beständigkeit gegen Verunreinigung und Schmutzansammlung. Daher ist auch die Reinigungs-, Pflege- und Austauschfrequenz sehr niedrig.

Eine nachhaltige Wahl

Mosa ist der einzige Fliesenhersteller weltweit, der über ein Cradle to Cradle Certified® Gold-Zertifikat verfügt. Dieses Zertifikat gilt auch für die Ultragres-Fliesen. Die Fliesen werden hauptsächlich aus den natürlichen Rohstoffen Lehm und Sand hergestellt. Während des Herstellungsprozesses finden ständig Qualitätskontrollen statt, und der Materialkreislauf in den Fabriken ist nahezu geschlossen. Außerdem stoßen die Fliesen keine Schadstoffe aus, sondern tragen zu einem gesunden Raumklima bei und können nach der Verwendung sicher entsorgt werden. Die Cradle to Cradle-Zertifizierung trägt zu positiven Bewertungen durch nationale und internationale Gütesiegel für nachhaltiges Bauen wie BREEAM NL, LEED, DGNB und HQE bei. Aufgrund ihrer herausragenden Eigenschaften sind Ultragres-Fliesen nahezu nicht verschleißanfällig. So bleibt die Qualität während der gesamten langen Lebensdauer gewährleistet. Daher sind diese Fliesen eine nachhaltige und verantwortungsbewusste Wahl.

Jedes gewünschte Design

Die einzigartigen Eigenschaften von Ultragres sorgen dafür, dass Ideen Wirklichkeit werden und auch bleiben. Da Mosa ihre Fliesendesigns und -farben selbst entwickelt, kann jede gewünschte Signatur und Identität geschaffen werden. Zur Festlegung des Farb- und Struktursortiments unterhält Mosa intensive Kontakte zum Markt und sorgt dafür, dass ständig neue Kreationen entstehen. Die Fliesen sind modular, sodass die Fugen von Wand- und Fußbodenfliesen miteinander kompatibel sind. Diese Eigenschaft und die Maßhaltigkeit der Fliesen tragen zu einer eleganten und luxuriösen Ausstrahlung bei. Fliesen mit unterschiedlichen Farben können problemlos miteinander kombiniert werden; außerdem ist es möglich, komplexe Muster mit schmalen Fugen ins Design aufzunehmen.

Mit anderen Worten: Mit Ultragres sind vielseitige Anwendbarkeit, hohe Nachhaltigkeit und hochwertiges Design während der gesamten Lebensdauer garantiert.

Exceptional quality

Ultragres tiles are the result of over 140 years of experience, knowledge, expertise, and passion for ceramics. The superior technical properties of the tiles allow them to perform well in terms of dimensional stability, flatness, breaking strength, bending strength, and resistance to serious wear and tear. Mosa's standards of tile performance go beyond the current international standards. Our tiles are produced sustainably and have a contemporary appearance. Their authentic character will remain intact throughout their service life, guaranteeing quality and aesthetics. These qualities make Ultragres tiles a reliable choice in terms of installation, sustainability, and design.

Trouble-free installation

Ultragres tiles can be installed in unique ways in terms of aesthetics and functionality. Notable hallmarks of the tiles include a high load-bearing capacity, slip resistance, ease of maintenance, and a long service life. Because the tiles can withstand heavy use, the authentic appearance of the design is guaranteed to last. Ultragres tiles are very suitable for heavily frequented environments, such as airports and train stations. Their anti-slip properties make Ultragres tiles an appropriate choice for places where safety is of high importance, such as showers and swimming pools. Even very high mechanical and chemical stress does not affect the tiles' quality. The tiles are highly resistant to pollution and adhesion of dirt. Because of this, the frequency with which the tiles have to be maintained and replaced is extremely low.

A sustainable choice

Mosa is the only tile company in the world with a Cradle to Cradle Certified® Gold certificate. The certificate also applies to the Ultragres tiles. The tiles consist mainly of the natural raw materials clay and sand. During the production process, constant quality control is performed and the material cycle in the factories forms a nearly closed loop. The tiles also do not emit harmful substances, but contribute to a healthy interior climate and can be safely removed. Our Cradle to Cradle certification contributes to positive scores from various Dutch, as well as international labels for sustainable building, such as BREEM NL, LEED, DGNB, and HQE. Thanks to their excellent properties, Ultragres tiles are extremely hard-wearing. This guarantees the quality of the tiles throughout their service life. All of the above properties make Ultragres tiles a very sustainable and responsible choice.

Every desired design

The unique properties of Ultragres tiles make sure that ideas become a reality and remain a reality. Because Mosa develops its own tile patterns and colours, it can create every desired signature and identity. In order to compose its colour and structure selection, Mosa stays in close contact with the market and thus continuously expands its array of creations. The tiles are modular, creating a seamless joint between the wall and the floor. Thanks to this quality and the dimensional stability of the tiles, a sleek and luxurious appearance can be created. It's very easy to mix different colours, and it's also possible to create designs with complex patterns using fine lines.

In short, Ultragres tiles guarantee installation quality, sustainability, and design throughout a long service life.



Support

Van ontwerp tot installatie en onderhoud: via Mosa Customer Service en online-diensten kunt u in elk stadium van het proces bij Mosa terecht. Natuurlijk ook voor monsters of een bezoek aan de Mosa Design Studios. De website en de Mosa Pattern Generator vergemakkelijken uw ontwerp- en keuzeproces. Mosa's projectadviseurs bezoeken u graag voor advies op maat voor uw project, geven graag toelichting over de producten en de toepassing hiervan.

www.mosa.com

De Mosa-website met slimme navigatiestructuur maakt alle informatie over Mosa-tegels in een handomdraai vindbaar. Met de handige zoekfunctionaliteit kan via verschillende zoekingen de juiste tegel worden gevonden. Internationale referenties en diverse tools zorgen voor inspiratie en ondersteunen het ontwerpproces.

Pattern Generator

Als ondersteuning bij het ontwerp is de Pattern Generator ontwikkeld, een handige online tool. De architect of ontwerper kan hiermee zelf een patroon ontwerpen, opties vergelijken en de selectie bewaren.

Documentatie

Alle producten voor de verschillende toepassingen worden ondersteund met actuele en nauwkeurige documentatie. Vraag online brochures aan of contacteer ons voor de juiste bestektekst.

Monsterservice

Een monster nodig om voor uw project de beslissing te maken voor de juiste kleurtoon? Vraag elk gewenst sample aan via onze website.

Referenties

Mosa-producten hebben wereldwijd bijgedragen aan bijzondere creaties en fraaie gebouwen. Bekijk referenties in elke gewenste toepassing. Van scholen en hotels tot ziekenhuizen en van woningbouw tot de retail.

Reinigingsadvies

Voor de reinigings- en onderhoudsadviezen zie www.mosa.com.

Technical data

Voor technische productbladen zie www.mosa.com. De Nederlandse bestekteksten zijn terug te vinden op www.mosa.com. In Nederland zijn de bestekteksten voor Mosa-projecttegels opgenomen in STABU en FBS.

Normen

Voor de certificaten NEN-EN-ISO 9001 / 14001 en CE-markeringen zie www.mosa.com.

Levertijden en bestelhoeveelheden

Voor informatie over levertijden en minimale bestelhoeveelheden (dit geldt voor sommige artikelen in onze collectie) verwijzen wij u naar onze website www.mosa.com of neem contact op met onze Customer Service.



De la conception à la réalisation voire l'entretien : le Mosa Customer Service et les services en ligne permettent un contact avec Mosa à chaque stade du processus. Il en est de même pour les échantillons ou une visite dans les Mosa Design Studios. Le site Internet et le Mosa Pattern Generator facilitent la création et le choix des produits. Les conseillers de projet Mosa se feront un plaisir de venir chez vous pour des conseils personnalisés à propos du produit et de la mise en application.

www.mosa.com

La structure de navigation intelligente du site Internet de Mosa permet de trouver très rapidement toutes les informations sur les carreaux de Mosa. Grâce à la fonctionnalité de recherche facile, il est possible de trouver le carreau qu'il vous faut en employant diverses entrées. Des références internationales et différents outils aident à l'inspiration et au bon déroulement des projets.

Pattern Generator

Pour aider dans la phase de conception, le Pattern Generator a été développé, un outil en ligne très pratique. Il permet à l'architecte ou au dessinateur de créer ses propres modèles, de comparer différentes options et de conserver la sélection.

Documentation

Tous les produits pour les différentes applications sont accompagnés d'une documentation actuelle et précise. Demandez les brochures en ligne ou contactez-nous afin d'obtenir le texte nécessaire pour votre cahier de charges.

Sample service

Besoin d'un échantillon pour décider de la bonne teinte pour votre projet ? Demandez celui qu'il vous faut par l'intermédiaire de notre site Internet.

Références

Les produits de Mosa ont contribué de par le monde à des créations originales et à l'édification de magnifiques bâtiments. Consultez les références selon les applications souhaitées. Des écoles ou hôtels aux hôpitaux et des constructions résidentielles aux surfaces commerciales.

Conseil de nettoyage

On peut trouver les conseils de nettoyage et entretien sur www.mosa.com.

Technical data

On peut trouver les fiches techniques sur www.mosa.com.

Normes

On peut trouver les certificats NEN-EN-ISO 9001 / 14001 et marquages CE sur www.mosa.com.

Délais de livraison et quantités commandées

Pour plus d'informations sur les délais de livraison et les quantités minimales par commande (ceci s'applique à certains articles de notre collection), veuillez consulter notre site Internet www.mosa.com ou contacter notre Customer Service.

Trouvez le point de vente Mosa le plus proche sur www.mosa.com. Appelez le +31 (0)43 368 92 29 ou consultez www.mosa.com.

Über Mosa Customer Service und die Onlinedienste können Sie sich in allen Prozessphasen vom Entwurf über die Realisierung bis hin zur Pflege an Mosa wenden. Natürlich erhalten Sie hier auch Muster und können einen Termin für einen Besuch in einem der Mosa Design Studios vereinbaren. Die Website und der Mosa Pattern Generator unterstützen Sie während des Entwurfs- und Entscheidungsprozesses. Die Projektberater von Mosa besuchen Sie gerne für eine individuelle Projektberatung, um Ihnen die Produkte und Anwendungsmöglichkeiten ausführlich vorzustellen.

www.mosa.com

Dank einer intelligenten Navigationsstruktur finden Sie auf der Mosa-Website im Handumdrehen alle Informationen über die Mosa-Fliesen. Mit der praktischen Suchfunktion können Sie unter den verschiedenen Sucheinträgen die richtigen Fliesen finden. Internationale Referenzen und diverse Tools bieten Inspiration und Unterstützung beim Entwurfsprozess.

Pattern Generator

Unterstützung beim Design bietet der Pattern Generator, ein praktisches Online-Tool, mit dem Architekten und Designer selbst Muster entwerfen, Optionen vergleichen und Ergebnisse speichern können.

Dokumentation

Die Dokumentation zu allen Produkten für die unterschiedlichen Anwendungen sind aktuell und umfassend. Sie können online Broschüren bestellen oder die passenden Ausschreibungstexte bei uns anfordern.

Musterservice

Brauchen Sie ein Muster, um bei Ihrem Projekt den richtigen Farbton auswählen zu können? Auf unserer Website können Sie alle Muster bestellen.

Referenzen

Mosa-Produkte sind auf der ganzen Welt in außergewöhnlichen Projekten und attraktiven Gebäuden zu finden. Unsere Referenzen bieten Beispiele für jede gewünschte Anwendung von Schulen und Hotels bis zu Krankenhäusern und von Wohnhäusern bis zu Einzelhandelsobjekten.

Reinigungsempfehlung

Für die Empfehlungen für Reinigung und Wartung siehe www.mosa.com.

Technical data

Für die technische Produktblätter siehe www.mosa.com.

Normen

Für die Zertifikate NEN-EN-ISO 9001 / 14001 und CE-Markierungen siehe www.mosa.com.

Lieferzeiten und Bestellmengen

Informationen zu Lieferzeiten und Mindestbestellmengen (dies gilt für einige Artikel aus unserer Kollektion) finden Sie auf unserer Website www.mosa.com oder wenden Sie sich an unseren Customer Service.

Finden Sie ein Mosa-Geschäft in Ihrer Nähe unter www.mosa.com. Rufen Sie uns an unter +31 (0)43 368 92 29 oder besuchen Sie www.mosa.com.



From initial design implementation and maintenance: you can consult Mosa Customer Service and online services during every stage of the process, to request samples or to schedule a visit to one of the Mosa Design Studios. The Mosa website and the Mosa Pattern Generator were created to facilitate the design and selection process. Mosa's project consultants would be happy to give tailored advice, visit you to discuss our products and their applications.

www.mosa.com

The smart navigation structure of the Mosa website makes it easy to find all of the information you need about Mosa tiles. Find the perfect tile by entering your search term into our convenient search toolbar. International references and various tools provide both inspiration and support during the design process.

Pattern Generator

The Pattern Generator has been developed as a simple and effective online tool to assist architects and designers in creating a pattern, comparing options, and saving the results.

Documentation

All products for the various applications are supported by up-to-date and accurate documentation. Request a brochure online or contact us for the right specifications.

Sample service

Need a sample to determine the right colour tone for your project? All samples can be requested at our website.

References

Mosa products have contributed to special creations and beautiful buildings around the world. You can see references for all applications, from schools and hotels to hospitals, homes, and retail establishments.

Cleaning advice

The cleaning and maintenance advices can be found on www.mosa.com.

Technical data

The technical product sheets can be found on www.mosa.com.

Standards

The certificates NEN-EN-ISO 9001 / 14001 and CE conformity markings can be found on www.mosa.com.

Delivery times and order quantities

For information on delivery times and minimum order quantities (applies to some items in our collection) please refer to our website www.mosa.com or contact our Customer Service team.

Icons & symbols

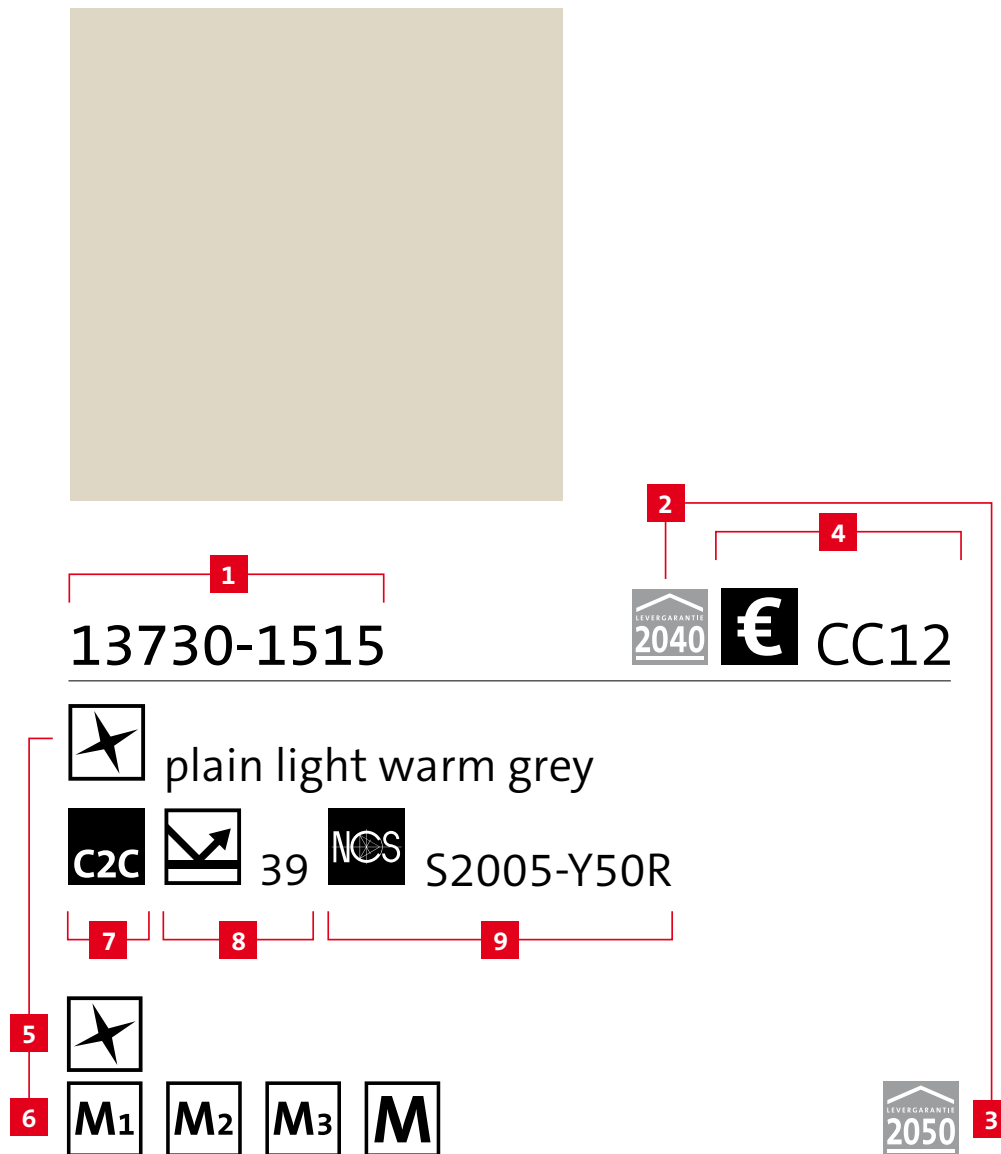

- 1 artikelnummer
- 2 nalevergarantie tot het jaar 2040
- 3 nalevergarantie tot het jaar 2050
- 4 prijsgroep
- 5 glanzend
- 6 poedermat / steenmat / zijdemat / mat
- 7 Cradle to Cradle Certified® Gold
- 8 lichtreflectiewaarde (indicatief)
- 9 best passende NCS-kleur

- 1 Artikelnummer
- 2 garantiert nachlieferbar bis 2040
- 3 garantiert nachlieferbar bis 2050
- 4 Preisgruppe
- 5 glänzend
- 6 pulvermatt / steinmatt / seidenmatt / matt
- 7 Cradle to Cradle Certified® Gold
- 8 Lichtreflektionswert (indikativ)
- 9 korrespondierende NCS-Farbe

- 1 numéro d'article
- 2 livraison garantie jusque 2040
- 3 livraison garantie jusque 2050
- 4 groupe de prix
- 5 brillant
- 6 mat poudré / mat pierre / satiné / mat
- 7 Cradle to Cradle Certified® Gold
- 8 valeur de réflectance (indicatif)
- 9 couleur NCS correspondant le mieux



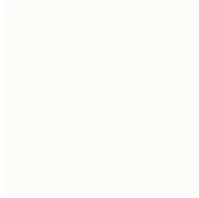

- 1 item number
- 2 guarantee after delivery until the year 2040
- 3 guarantee after delivery until the year 2050
- 4 price group
- 5 gloss
- 6 powdermatt / stonematt / satin / matt
- 7 Cradle to Cradle Certified® Gold
- 8 light reflectance value (indicative)
- 9 best matching NCS-colour



Holland 2040 10 



0490M1515  € U 0

 white

  81

Global Collection 11 



75075S1515  € CP35

 flaked bronze yellow

12  DP, DI, DU, BN, LS

13  LS

14   R10 B

  29  S 3020-Y40R

LS 15 



76015LS1515  € CP26

 flaked moonstone white

 DP, DI, DU, LS, BN

  R11 B





















  47  S 1500-N

- 10 wandtegel 15 x 15 cm
- 11 vloertegel 15 x 15 cm
- 12 in deze kleur leverbare vloertegelaccessoires
- 13 overige, in deze kleur leverbare formaten en tegels
- 14 productnormen
- 15 reliëftegel

- 10 Wandfliese 15 x 15 cm
- 11 Bodenfliese 15 x 15 cm
- 12 in dieser Farbe lieferbare Bodenfliesen-Formteile
- 13 übrige, in dieser Farbe lieferbare Formate und Fliesen
- 14 Produktnormen
- 15 Relieffliese

- 10 carreau de faïence 15 x 15 cm
- 11 carreau de sol 15 x 15 cm
- 12 accessoires pour carreaux de sol disponibles dans cette couleur
- 13 autres formats et carreaux disponibles dans cette couleur
- 14 normes de produit
- 15 carreau en relief

- 10 wall tile 15 x 15 cm
- 11 floor tile 15 x 15 cm
- 12 accessories for floor tiles available in this colour
- 13 other sizes and tiles available in this colour
- 14 product standards
- 15 relief tile

	nalevergarantie tot het jaar 2040	livraison garantie jusqu'en 2040	garantiert nachlieferbar bis 2040	guarantee after delivery until the year 2040
	nalevergarantie tot het jaar 2050	livraison garantie jusqu'en 2050	garantiert nachlieferbar bis 2050	guarantee after delivery until the year 2050
	prijsgroep	groupe de prix	Preisgruppe	price group
	glanzend	brillant	glänzend	gloss
	poedermat	mat poudré	pulvermatt	powdermatt
	steenmat	mat pierre	steinmatt	stonematt
	zijdemat	satiné	seidenmatt	satin
	mat	mat	matt	matt
	in deze kleur leverbare wandtegellaccessoires	accessoires pour carreaux de faïences disponibles dans cette couleur	in dieser Farbe lieferbare Wandfliesen-Formteile	accessories for wall tiles, available in this colour
	in deze kleur leverbare vloertegellaccessoires	accessoires pour carreaux de sol disponibles dans cette couleur	in dieser Farbe lieferbare Bodenfliesen-Formteile	accessories for floor tiles, available in this colour
	overige, in deze kleur leverbare wandtegelformaten	autres formats carreaux de faïences disponibles dans cette couleur	übrige, in dieser Farbe lieferbare Wandfliesen-Formate	other sizes wall tiles, available in this colour
	overige, in deze kleur leverbare vloertegelformaten	autres formats carreaux de sol disponibles dans cette couleur	übrige, in dieser Farbe lieferbare Bodenfliesen-Formate	other sizes floor tiles, available in this colour
	in deze kleur en dit formaat leverbare reliëfvloertegels	carreaux de sol en relief disponibles dans cette couleur et ce format	in dieser Farbe und diesen Format lieferbare Relief Bodenfliesen	relief floor tiles, available in this colour and size
	in dit formaat en deze kleur leverbare Holland 2050 prefab tegelpanelen			
	vorstbestand	ingélif	frostsicher	frost proof
	gerectificeerd	rectifié	rektifiziert	rectified
	loopveiligheid R*, V	antidérapance R*, V	Trittsicherheit R*, V	slip resistance R*, V
	loopveiligheid A, B, C	antidérapance A, B, C	Trittsicherheit A, B, C	slip resistance A, B, C
	Cradle to Cradle Certified® Gold	Cradle to Cradle Certified® Gold	Cradle to Cradle Certified® Gold	Cradle to Cradle Certified® Gold
	lichtreflectiewaarde (indicatief)	valeur de réflectance (indicatif)	Lichtreflektionswert (indikativ)	light reflectance value (indicative)
	best passende NCS-kleur	couleur NCS correspondant le mieux	korrespondierende NCS-Farbe	best matching NCS-colour

- * Waarschuwing: De weergegeven loopveiligheidswaarde bij aflevering is indicatief en kan in voorkomend geval afwijken. Op aanvraag kan Mosa een certificering met een exactere waarde per individuele partij tegels verstrekken.
- * Avertissement : L'indice d'antiglissance indiqué à la livraison est uniquement fourni à titre indicatif et peut varier le cas échéant. Mosa peut fournir sur demande une certification contenant un indice plus précis par lot individuel de carreaux.
- * Warnung: Der angegebene Trittsicherheitswert bei Auslieferung ist nur ein Richtwert und kann im Einzelfall variieren. Auf Anfrage kann Mosa eine Zertifizierung mit einem genaueren Wert pro Fliesencharge abgeben.
- * Warning: The displayed slip resistance value on delivery is indicative and may vary in particular cases. Upon request, Mosa can provide a certification with a more precise value for each individual batch of tiles.

AS	reliëftegel	carreau en relief	Relieffliese	relief tile
BN	plint	plinthe droite	Stehsockel	skirting (bullnose)
BP	plint	plinthe droite	Stehsockel	skirting (bullnose)
CR	Mosa Stage-reliëftegel	Mosa Stage carreau en relief	Mosa Stage-Relieffliese	Mosa Stage relief tile
CS1MR	douchetegel			shower tile
CW1MR	douchetegel			shower tile
DI	inwendig hoekje voor DP	angle intérieur pour DP	Innenecke für DP	internal angle for DP (inside angle)
DP	dunne holplint	plinthe à gorge fine	dünner Hohlkehlssockel	thin coved skirting (thin cove base)
DU	uitwendig hoekje voor DP	angle extérieur pour DP	Außenecke für DP	external angle for DP (outside angle)
GL	guideline	guideline	guideline	guideline
GS	guidestop	guidestop	guidestop	guidestop
HA	hoekafdek	2 bords arrondis	Eckabdeck	2 round edges (double bullnose)
HM	douchebakhoekplint	angle rentrant	Eckformstück	sloping shower corner piece
HR	douchebakhoekplint	angle rentrant	Eckformstück	sloping shower corner piece
HS	douchebakhoekplint	angle rentrant	Eckformstück	sloping shower corner piece
HV	traptegel (met hoek)	nez de marche (avec coin)	Treppenfliese (mit Ecke)	stair tread (with corner)
I	inwendig hoekje voor P	angle intérieur pour P	Innenecke für P	internal angle for P (inside angle)
L	lange zijde geglazuurd	côté long émaillé	Längsseite glasiert	longest edge glazed
LL	lange zijde geglazuurd	côté long émaillé	Längsseite glasiert	longest edge glazed
LS	reliëftegel	carreau en relief	Relieffliese	relief tile
M	moduul	module	modul	module
MR	microreliëftegel	carreau en microrelief	Mikroreliëffliese	microrelief tile
P	holplint	plinthe à gorge	Hohlkehlssockel	coved skirting (cove base)
RA	randafdek	bord arrondi	Randabdeck	round edge (bullnose)
RL	reliëftegel	carreau en relief	Relieffliese	relief tile
RM	reliëftegel	carreau en relief	Relieffliese	relief tile
RQ	reliëftegel	carreau en relief	Relieffliese	relief tile
S	vlak	lisse	flach	smooth
SP	holplint	plinthe à gorge	Hohlkehlssockel	coved skirting (cove base)
TGG	traptegel (rechte, geglazuurde voorzijde)	nez de marche (bord droit, côté émaillé)	Treppenfliese (eckige, überglasierte Kante)	stair tread (straight, glazed edge)
TS	reliëftegel	carreau en relief	Relieffliese	relief tile
TVG	traptegel (rechte, geglazuurde voorzijde)	nez de marche (bord droit, côté émaillé)	Treppenfliese (eckige, überglasierte Kante)	stair tread (straight, glazed edge)
U	uitwendig hoekje voor P	angle extérieur pour P	Außenecke für P	external angle for P (outside angle)
V	vlak	lisse	flach	smooth
VM	douchebakplint	pièce courante	Gefälleformstück	sloping shower edge tile
VR	douchebakplint	pièce courante	Gefälleformstück	sloping shower edge tile
VS	douchebakplint	pièce courante	Gefälleformstück	sloping shower edge tile
VV	vlak	lisse	flach	smooth
WS	reliëftegel	carreau en relief	Relieffliese	relief tile
XV	vlak	lisse	flach	smooth
YV	vlak	lisse	flach	smooth
ZV	vlak	lisse	flach	smooth

Mosa.

Wall tiles

Wall tiles

10
10

Classics Kho Liang Ie Collection
Global Collection

10
20

Classics Trocadero
Tide

10
30

Global Collection

15
15

Classics Foxtrot
Colors
Global Collection
Murals Blend
Murals Change
Murals Fuse
Murals Lines

15
20

Holland 2050

15
30

15thirty Accent
Global Collection
Holland 2050
Murals Blend
Murals Change
Murals Fuse
Murals Lines

20
25

Holland 2050

30
30

Murals Blend
Murals Fuse

30
60

Murals Blend

10/10 Classics Kho Liang Ie Collection

wandtegels / carreaux de faïence / Wandfliesen / wall tiles
 geglazuurd / émaillé / glasiert / glazed
 niet vorstbestand / non ingélif / nicht frostsicher / not frost proof

no.	mm	inch	pieces/ m ²	pieces/ m ¹	pieces/ box	boxes/ pallet	pieces/ pallet	m ² / pallet	kg/ m ²	kg/ pallet
16900 - 16904	97x97x7,8	3.82x3.82x0.31	100	-	50 = 0,50 m ²	90	4.500	45,0	11,9	561
16905 - 16906	97x97x7,8	3.82x3.82x0.31	100	-	44 = 0,44 m ²	90	3.960	39,6	12,7	528

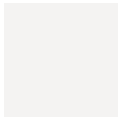

16900-1010 € CC13

✈ accent wit / blanc accent /
Akzent weiß / accent white



✈ 85 NCS S 0502-R50B GL



16901-1010 € AC01

✈ accent wit / blanc accent /
Akzent weiß / accent white



✈ 85



16902-1010 € AC01

✈ accent wit / blanc accent /
Akzent weiß / accent white



✈ 85



16903-1010 € AC01

✈ accent wit / blanc accent /
Akzent weiß / accent white



✈ 85



16904-1010 € AC01

✈ accent wit / blanc accent /
Akzent weiß / accent white



✈ 85



16905-1010 € AC01

✈ accent wit / blanc accent /
Akzent weiß / accent white



✈ 85



16906-1010 € AC01

✈ accent wit / blanc accent /
Akzent weiß / accent white













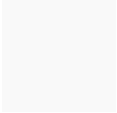







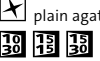



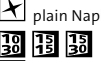



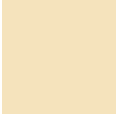
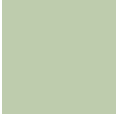

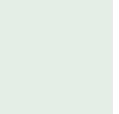
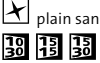



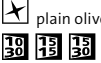

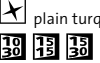

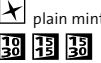



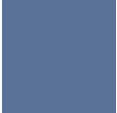
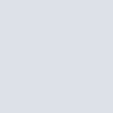

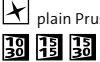



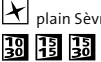





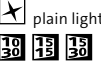



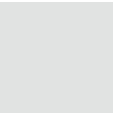











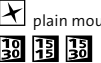



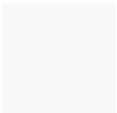



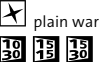

✈ 85

10 Global Collection

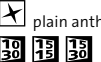

wandtegels / carreaux de faïence / Wandfliesen / wall tiles
 geglazuurd / émaillé / glasiert / glazed
 niet vorstbestand / non ingélif / nicht frostsicher / not frost proof

bijpassende vloertegels / carreaux de sol correspondants /
 dazugehörige Bodenfliesen / matching floor tiles
 Global Collection 











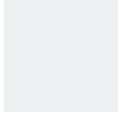
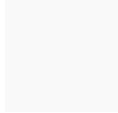
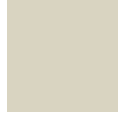



























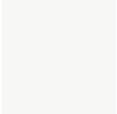

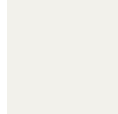





























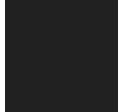































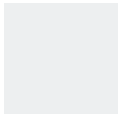



no.	mm	inch	pieces/ m ²	pieces/ m ¹	pieces/ box	boxes/ pallet	pieces/ pallet	m ² / pallet	kg/ m ²	kg/ pallet
13100 - 26250	97x97x7,8	3.82x3.82x0.31	100	-	50 = 0,50 m ²	90	4.500	45,0	11,9	561

			
13100-1010 € CC13  plain white   69  S 0603-R40B	13730-1010 € CC13  plain light warm grey   39  S 2005-Y50R GL	16650-1010 € CC13  plain agate grey   25  S 5005-Y50R GL	16670-1010  € CC13  plain Naples yellow   44  S 2030-Y20R GL
			
16680-1010 € CC13  plain sand yellow   21  S 2020-Y20R GL	16700-1010 € CC13  plain olive green   24  S 3020-G20Y GL	16720-1010 € CC13  plain turquoise   14  S 6020-B30G GL	16730-1010 € CC13  plain mint green   46  S 1005-G20Y GL
			
16750-1010 € CC13  plain Prussian blue   10  S 6020-R90B GL	16760-1010 € CC13  plain Sèvres blue   38  S 2020-R90B GL	16780-1010 € CC13  plain dove blue   38  S 4005-R80B GL	16820-1010 € CC13  plain light oxide red   26  S 4020-Y70R GL
			
16850-1010 € CC13  plain ivory black   12  S 8000-N GL	16860-1010 € CC13  plain white unbleached   78  S 1005-Y10R GL	16870-1010 € CC13  plain grey   51  S 3000-N GL	16880-1010 € CC13  plain mouse grey   27  S 5500-N GL
			
16900-1010 € CC13  plain accent white   85  S 0502-R50B GL	16910-1010 € CC13  plain black   5  S 9000-N GL	26240-1010 € CC13  plain warm grey   15  S 7005-Y20R GL	26250-1010 € CC13  plain anthracite   16  S 6500-N GL

wandtegels / carreaux de faïence / Wandfliesen / wall tiles
 geglazuurd / émaillé / glasiert / glazed
 niet vorstbestand / non ingélif / nicht frostsicher / not frost proof

bijpassende vloertegels / carreaux de sol correspondants /
 dazugehörige Bodenfliesen / matching floor tiles
 Global Collection   

no.	mm	inch	pieces/ m ²	pieces/ m ¹	pieces/ box	boxes/ pallet	pieces/ pallet	m ² / pallet	kg/ m ²	kg/ pallet
26260 - 26270	97x97x7,8	3.82x3.82x0.31	100	-	50 = 0,50 m ²	90	4.500	45,0	11,9	561

			
26260-1010  CC13  plain Sienna red     11  S 5030-Y70R GL	26270-1010  CC13  plain white grey     48  S 1505-Y90R GL	13000-1010  CC13  plain white     78  S0603-R40B	13630-1010  CC13  plain light warm grey     32  S 2005-Y50R
			
15010-1010  CC13  plain accent white     78  S 1002-Y50R	15050-1010  CC13  plain agate grey     24  S 5005-Y50R	15200-1010  CC13  plain ivory black     10  S 8000-N	15210-1010  CC13  plain white unbleached     68  S 1005-Y10R
			
15220-1010  CC13  plain grey     44  S 3000-N	15230-1010  CC13  plain mouse grey     27  S 5500-N	15240-1010  CC13  plain black     5  S 9000-N	25240-1010  CC13  plain warm grey      16  S 7005-Y20R
			
25250-1010  CC13  plain anthracite     16  S 6500-N	25270-1010  CC13  plain white grey     47  S 1505-Y90R		

10/20 Classics Trocadero

wandtegels / carreaux de faïence / Wandfliesen / wall tiles
 geglaazuurd / émaillé / glasiert / glazed
 niet vorstbestand / non ingélif / nicht frostsicher / not frost proof

no.	mm	inch	pieces/ m ²	pieces/ m ¹	pieces/ box	boxes/ pallet	pieces/ pallet	m ² / pallet	kg/ m ²	kg/ pallet
1001 - 1011	97x197x9	3.82x7.76x0.35	50	-	18 = 0,36 m ²	182	3.276	65,5	14,1	949
1003 - 1013	97x97x9	3.82x3.82x0.35	100	-	25 = 0,25 m ²	256	6.400	64,0	13,3	876



1001-1020

€ BC05

zwart / noir /
schwarz / black



C2C 5



1011-1020

€ BC05

klassiek wit / blanc classique /
weiß klassik / white classic



C2C 82



1003-1010

€ D 21

zwart / noir /
schwarz / black



C2C 5



1013-1010

€ D 21

klassiek wit / blanc classique /
weiß klassik / white classic



C2C 82

10/20 Tide

wandtegels / carreaux de faïence / Wandfliesen / wall tiles
 geglazuurd / émaillé / glasiert / glazed
 niet vorstbestand / non ingélif / nicht frostsicher / not frost proof

no.	mm	inch	pieces/ m ²	pieces/ m ¹	pieces/ box	boxes/ pallet	pieces/ pallet	m ² / pallet	kg/ m ²	kg/ pallet
0601 - 0610	97x197x6,3	3.82x7.76x0.25	50	-	25 = 0,50 m ²	182	4.550	91,0	10,2	928



0601-1020

€ BC09

serene white

c2c 69



0602-1020

€ BC09

blush

c2c 60



0603-1020

€ BC09

sage

c2c 44



0604-1020

€ BC09

blue mist

c2c 50



0605-1020

€ BC09

fog grey

c2c 57



0606-1020

€ BC09

bone

c2c 65



0607-1020

€ BC09

rust

c2c 11



0608-1020

€ BC09

charcoal grey

c2c 8



0609-1020

€ BC09

sand

c2c 48



0610-1020

€ BC09

forest green

c2c 13

10/30 Global Collection

wandtegels / carreaux de faïence / Wandfliesen / wall tiles
 geglaazuurd / émaillé / glasiert / glazed
 niet vorstbestand / non ingélif / nicht frostsicher / not frost proof

bijpassende vloertegels / carreaux de sol correspondants /
 dazugehörige Bodenfliesen / matching floor tiles
 Global Collection 10/30 15/30 30/30

no.	mm	inch	pieces/ m ²	pieces/ m ¹	pieces/ box	boxes/ pallet	pieces/ pallet	m ² / pallet	kg/ m ²	kg/ pallet
13100 - 16870	97x297x7,8	3.82x11.69x0.31	33	-	33 = 1,00 m ²	77	2.541	77,0	13,0	1.024

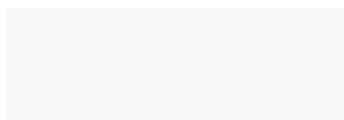

13100-1030 € CC11

✈ plain white
 10 15 30
 c2c 69 NCS S 0603-R40B



13730-1030 € CC11

✈ plain light warm grey
 10 15 30
 c2c 39 NCS S 2005-Y50R



16650-1030 € CC11

✈ plain agate grey
 10 15 30
 c2c 25 NCS S 5005-Y50R GL



16670-1030 € CC11

✈ plain Naples yellow
 10 15 30
 c2c 44 NCS S 2030-Y20R GL



16680-1030 € CC11

✈ plain sand yellow
 10 15 30
 c2c 21 NCS S 2020-Y20R GL



16700-1030 € CC11

✈ plain olive green
 10 15 30
 c2c 24 NCS S 3020-G20Y GL



16720-1030 € CC11

✈ plain turquoise
 10 15 30
 c2c 14 NCS S 6020-B30G GL

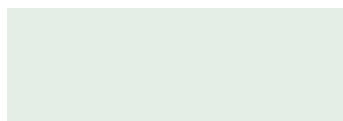

16730-1030 € CC11

✈ plain mint green
 10 15 30
 c2c 46 NCS S 1005-G20Y GL



16750-1030 € CC11

✈ plain Prussian blue
 10 15 30
 c2c 10 NCS S 6020-R90B GL



16760-1030 € CC11

✈ plain Sèvres blue
 10 15 30
 c2c 38 NCS S 2020-R90B GL

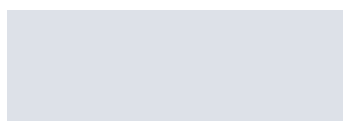

16780-1030 € CC11

✈ plain dove blue
 10 15 30
 c2c 38 NCS S 4005-R80B GL



16820-1030 € CC11

✈ plain light oxide red
 10 15 30
 c2c 26 NCS S 4020-Y70R GL



16850-1030 € CC11

✈ plain ivory black
 10 15 30
 c2c 12 NCS S 8000-N GL

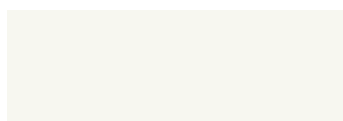

16860-1030 € CC11

✈ plain white unbleached
 10 15 30
 c2c 78 NCS S 1005-Y10R GL



16870-1030 € CC11

✈ plain grey
 10 15 30
 c2c S 3000-N GL

1030 Global Collection

wandtegels / carreaux de faïence / Wandfliesen / wall tiles
 geglazuurd / émaillé / glasiert / glazed
 niet vorstbestand / non ingélif / nicht frostsicher / not frost proof

bijpassende vloertegels / carreaux de sol correspondants /
 dazugehörige Bodenfliesen / matching floor tiles
 Global Collection 1030 1530 3030

no.	mm	inch	pieces/ m ²	pieces/ m ¹	pieces/ box	boxes/ pallet	pieces/ pallet	m ² / pallet	kg/ m ²	kg/ pallet
16880 - 15890	97x297x7,8	3.82x11.69x0.31	33	-	33 = 1,00 m ²	77	2.541	77,0	13,0	1.024



16880-1030 € CC11

plain mouse grey
 S 5500-N GL

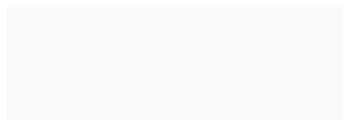

16900-1030 € CC11

plain accent white
 S 0502-R50B GL



16910-1030 € CC11

plain black
 S 9000-N GL



26240-1030 € CC11

plain warm grey
 S 7005-Y20R GL



26250-1030 € CC11

plain anthracite
 S 6500-N GL



26260-1030 € CC11

plain Sienna red
 S 5030-Y70R GL

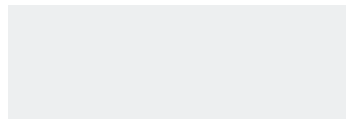

26270-1030 € CC11

plain white grey
 S 1505-Y90R GL

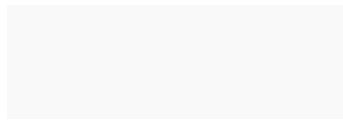

13000-1030 € CC11

plain white
 S 0603-R40B



15240-1030 € CC11

plain black
 S 9000-N

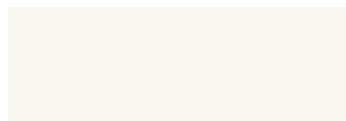

15800-1030 € CC11

plain white unbleached
 S 1005-Y10R

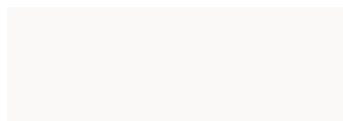

15810-1030 € CC11

plain accent white
 S 1002-Y50R

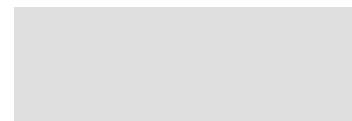

15820-1030 € CC11

plain grey
 S 2502-Y80R



15830-1030 € CC11

plain mouse grey
 S 5000-N

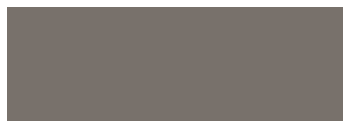

15850-1030 € CC11

plain agate grey
 S 5005-Y50R



15890-1030 € CC11

plain ivory black
 S 8000-N

wandtegels / carreaux de faïence / Wandfliesen / wall tiles
 geglaazuurd / émaillé / glasiert / glazed
 niet vorstbestand / non ingélif / nicht frostsicher / not frost proof

bijpassende vloertegels / carreaux de sol correspondants /
 dazugehörige Bodenfliesen / matching floor tiles
 Global Collection

no.	mm	inch	pieces/ m ²	pieces/ m ¹	pieces/ box	boxes/ pallet	pieces/ pallet	m ² / pallet	kg/ m ²	kg/ pallet
15960 - 15990	97x297x7,8	3.82x11.69x0.31	33	-	33 = 1,00 m ²	77	2.541	77,0	13,0	1.024



15960-1030

plain warm grey



9 S 6502-R



15970-1030

plain anthracite



10 S 6500-N

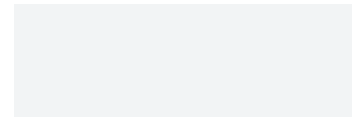

15980-1030

plain white grey



46 S 1505-Y90R



15990-1030

plain light warm grey



33 S 2005-Y50R

1515 Classics Foxtrot

wandtegels / carreaux de faïence / Wandfliesen / wall tiles
 geglazuurd / émaillé / glasiert / glazed
 niet vorstbestand / non ingélif / nicht frostsicher / not frost proof

no.	mm	inch	pieces/ m ²	pieces/ m ¹	pieces/ box	boxes/ pallet	pieces/ pallet	m ² / pallet	kg/ m ²	kg/ pallet
7820	147x147x7	5.79x5.79x0.28	44	-	33 = 0,75 m ²	115	3.795	86,3	11,8	1.046
7820RA	147x147x6,8	5.79x5.79x0.27	-	6,67	33 = 4,95 m ¹	100	3.300	-	-	916
7820HA	147x147x6,8	5.79x5.79x0.27	-	-	10	300	3.000	-	-	814
7851	147x25x6,8	5.79x0.98x0.27	267	6,67	20 = 3,00 m ¹	832	16.640	62,3	-	857

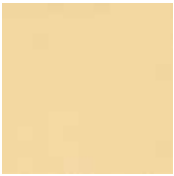

7820-1515 € BC04

ivoor / ivoire /
 elfenbein / ivory

RA, HA

C2C 67

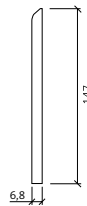

7820RA1515 € D 38

ivoor / ivoire /
 elfenbein / ivory

randafdek / bord arrondi /
 Randabdeck / round edge (bullnose)

C2C 67

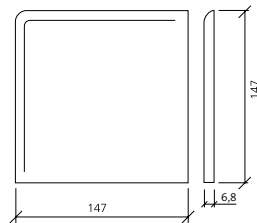

7820HA1515 € D 38

ivoor / ivoire /
 elfenbein / ivory

hoekafdek / 2 bords arrondis /
 Eckabdeck / 2 round edges (double
 bullnose)

C2C 67





7851-153-A € D 38

zwart / noir /
 schwarz / black

1515 Colors

wandtegels / carreaux de faïence / Wandfliesen / wall tiles
 geglaazuurd / émaillé / glasiert / glazed
 niet vorstbestand / non ingélif / nicht frostsicher / not frost proof

bijpassende vloertegels / carreaux de sol correspondants /
 dazugehörige Bodenfliesen / matching floor tiles
 Global Collection   

no.	mm	inch	pieces/ m ²	pieces/ m ¹	pieces/ box	boxes/ pallet	pieces/ pallet	m ² / pallet	kg/ m ²	kg/ pallet
16660 - 18970	147x147x5,6	5.79x5.79x0.22	44	-	44 = 1,00 m ²	100	4.400	100,0	9,2	940

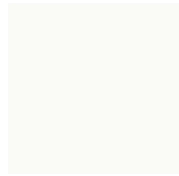

16660-1515   CC12

 plain ivory white



  82  S 0505-Y10R GL



16690-1515   CC12

 plain pearl green



  80  S 0505-G20Y GL

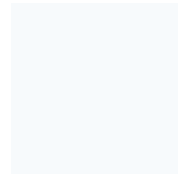

16740-1515   CC12

 plain pearl blue



  80  S 0505-R90B GL

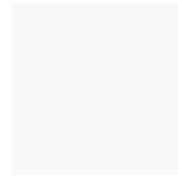

16790-1515   CC12

 plain ivory



  78  S 1010-Y30R GL



17900-1515   CC12

 plain macaw green



  45  S 0560-G40Y GL



17910-1515  CC12

 plain cyan blue



  29  S 2050-B GL



17920-1515  CC12

 plain spectrum blue



  6  S 6030-R60B GL



17930-1515  CC12

 plain clover



  14  S 4040-R40B GL



17950-1515  CC12

 plain spectra yellow



  53  S 0570-Y10R GL



17990-1515  CC12

 plain blue curacao



  30  S 2040-B20G GL



18900-1515  CC12

 plain ambrosia



  67  S 1020-G40Y GL



18910-1515  CC12

 plain brilliant blue



  18  S 3050-R90B GL



18920-1515  CC12

 plain royal blue



  13  S 4040-R70B GL



18940-1515  CC12

 plain apricot tan



  46  S 1040-Y30R GL



18950-1515  CC12

 plain cornsilk



  71  S 1030-Y GL



18970-1515  CC12



 plain peach blossom



  39  S 2030-R10B GL

15 Colors



wandtegels / carreaux de faïence / Wandfliesen / wall tiles
 geglazuurd / émaillé / glasiert / glazed
 niet vorstbestand / non ingélf / nicht frostsicher / not frost proof

bijpassende vloertegels / carreaux de sol correspondants /
 dazugehörnde Bodenfliesen / matching floor tiles
 Global Collection   

no.	mm	inch	pieces/ m ²	pieces/ m ¹	pieces/ box	boxes/ pallet	pieces/ pallet	m ² / pallet	kg/ m ²	kg/ pallet
18990 - 20910	147x147x5,6	5.79x5.79x0.22	44	-	44 = 1,00 m ²	100	4.400	100,0	9,2	940





18990-1515  CC12

  51  S 1030-B90G GL



19900-1515  CC12

  52  S 1030-G30Y GL





19910-1515  CC12

  45  S 0540-B GL



19920-1515  CC12

  39  S 2030-R80B GL



19950-1515  CC12

  43  S 2040-Y10R GL



19970-1515  CC12

  12  S 4040-R10B GL





19990-1515  CC12

  37  S 2040-G GL



20610-1515  CC12

  12  S 4030-R90B GL



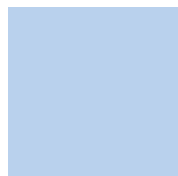

20640-1515  CC12

  35  S 2050-Y40R GL





20710-1515  CC12

  30  S 1040-R90B GL



20730-1515  CC12

  19  S 3040-R20B GL





20740-1515  CC12

  17  S 3050-Y80R GL





20750-1515  CC12

  12  S 6010-Y50R GL





20790-1515  CC12

  10  S 4060-B90G GL





20900-1515  CC12

  9  S 7010-G10Y GL



20910-1515  CC12

  6  S 7020-R80B GL

1515 Colors

wandtegels / carreaux de faïence / Wandfliesen / wall tiles
 geglaazuurd / émaillé / glasiert / glazed
 niet vorstbestand / non ingélif / nicht frostsicher / not frost proof

bijpassende vloertegels / carreaux de sol correspondants /
 dazugehörige Bodenfliesen / matching floor tiles
 Global Collection 

no.	mm	inch	pieces/ m ²	pieces/ m ¹	pieces/ box	boxes/ pallet	pieces/ pallet	m ² / pallet	kg/ m ²	kg/ pallet
20920 - 20990	147x147x5,6	5.79x5.79x0.22	44	-	44 = 1,00 m ²	100	4.400	100,0	9,2	940



20920-1515  CC12

 plain persian jewel
  22  S 3040-R70B GL







20930-1515  CC12

 plain eggplant
  6  S 8010-R30B GL







20960-1515  CC12

 plain beech
  12  S 7005-G80Y GL



20990-1515  CC12











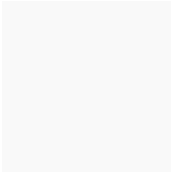
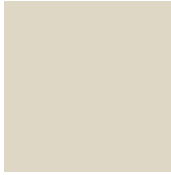
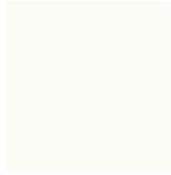

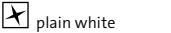



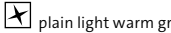



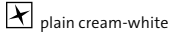





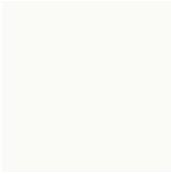
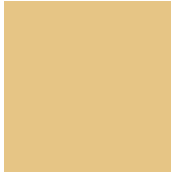
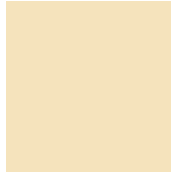
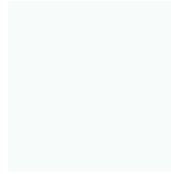

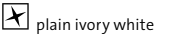



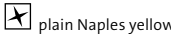







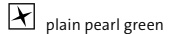



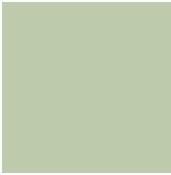
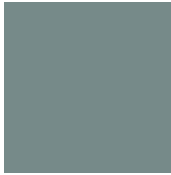

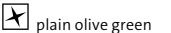



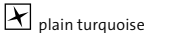









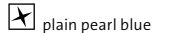

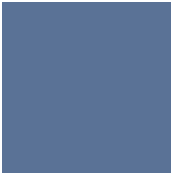
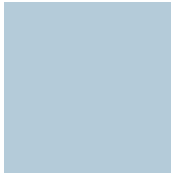
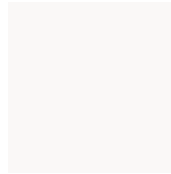

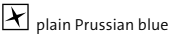



 plain oriental blue
  8  S 6030-B GL

15 15 Global Collection

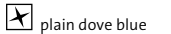
wandtegels / carreaux de faïence / Wandfliesen / wall tiles
 geglaazuurd / émaillé / glasiert / glazed
 niet vorstbestand / non ingélif / nicht frostsicher / not frost proof

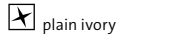
bijpassende vloertegels / carreaux de sol correspondants /
 dazugehörnde Bodenfliesen / matching floor tiles
 Global Collection 10 15 30

no.	mm	inch	pieces/ m ²	pieces/ m ¹	pieces/ box	boxes/ pallet	pieces/ pallet	m ² / pallet	kg/ m ²	kg/ pallet
13100 - 16790	147x147x5,6	5.79x5.79x0.22	44	-	44 = 1,00 m ²	100	4.400	100,0	9,2	940

			
13100-1515   plain white   69  S 0603-R40B GL	13730-1515   plain light warm grey   39  S 2005-Y50R GL	16610-1515   plain cream-white   84  S 0502-Y GL	16650-1515   plain agate grey   25  S 5005-Y50R GL
			
16660-1515   plain ivory white   82  S 0505-Y10R GL	16670-1515   plain Naples yellow   52  S 2030-Y20R GL	16680-1515   plain sand yellow   64  S 2020-Y20R GL	16690-1515   plain pearl green   80  S 0505-G20Y GL
			
16700-1515   plain olive green   36  S 3020-G20Y GL	16720-1515   plain turquoise   23  S 6020-B30G GL	16730-1515   plain mint green   62  S 1005-G20Y GL	16740-1515   plain pearl blue   80  S 0505-R90B GL
			
16750-1515   plain Prussian blue   19  S 6020-R90B GL	16760-1515   plain Sèvres blue   54  S 2020-R90B GL	16780-1515   plain dove blue   51  S 4005-R80B GL	16790-1515   plain ivory   78  S 1010-Y30R GL

1515 Global Collection





wandtegels / carreaux de faïence / Wandfliesen / wall tiles
 geglazuurd / émaillé / glasiert / glazed
 niet vorstbestand / non ingélif / nicht frostsicher / not frost proof

bijpassende vloertegels / carreaux de sol correspondants /
 dazugehörige Bodenfliesen / matching floor tiles
 Global Collection 

no.	mm	inch	pieces/ m ²	pieces/ m ¹	pieces/ box	boxes/ pallet	pieces/ pallet	m ² / pallet	kg/ m ²	kg/ pallet
16820 - 15050	147x147x5,6	5.79x5.79x0.22	44	-	44 = 1,00 m ²	100	4.400	100,0	9,2	940





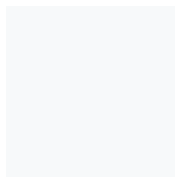

16820-1515  CC12

 plain light oxide red

  S 4020-Y70R GL







16840-1515  CC12

 plain cool white

  S 1002-R50B GL





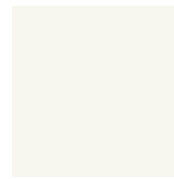

16850-1515  CC12

 plain ivory black

  S 8000-N GL





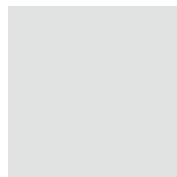

16860-1515  CC12

 plain white unbleached

  S 1005-Y10R GL





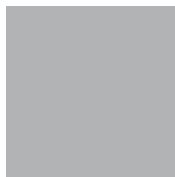

16870-1515  CC12

 plain grey

  S 3000-N GL





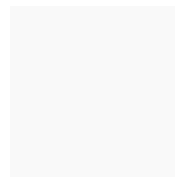

16880-1515  CC12

 plain mouse grey

  S 5500-N GL







16900-1515  CC12

 plain accent white

  S 0502-R50B GL







16910-1515  CC12

 plain black

  S 9000-N GL







26240-1515  CC12

 plain warm grey

  S 7005-Y20R GL







26250-1515  CC12

 plain anthracite

  S 6500-N GL





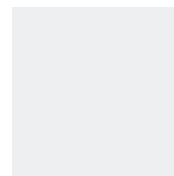

26260-1515  CC12

 plain Sienna red

  S 5030-Y70R GL





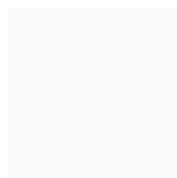

26270-1515  CC12

 plain white grey

  S 1505-Y90R





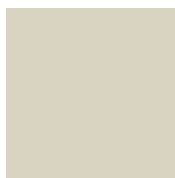

13000-1515  CC12

 plain white

  S 0603-R40B





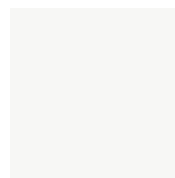

13630-1515  CC12

 plain light warm grey

  S 2005-Y50R







15010-1515  CC12

 plain accent white

  S 1002-Y50R



15050-1515  CC12

 plain agate grey

  S 5005-Y50R

1515 Global Collection

wandtegels / carreaux de faïence / Wandfliesen / wall tiles
 geglaazuurd / émaillé / glasiert / glazed
 niet vorstbestand / non ingélf / nicht frostsicher / not frost proof

bijpassende vloertegels / carreaux de sol correspondants /
 dazugehörige Bodenfliesen / matching floor tiles
 Global Collection 10 15 30

no.	mm	inch	pieces/ m ²	pieces/ m ¹	pieces/ box	boxes/ pallet	pieces/ pallet	m ² / pallet	kg/ m ²	kg/ pallet
15060 - 25250	147x147x5,6	5.79x5.79x0.22	44	-	44 = 1,00 m ²	100	4.400	100,0	9,2	940



15060-1515 € CC12

M₃ plain Naples yellow
 c2c 45 NCS S 2030-Y20R



15070-1515 € CC12

M₃ plain sand yellow
 c2c 54 NCS S 2020-Y20R

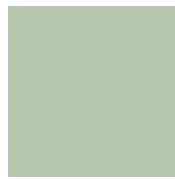

15080-1515 € CC12

M₃ plain olive green
 c2c 37 NCS S 3020-G20Y



15100-1515 € CC12

M₃ plain turquoise
 c2c 21 NCS S 6020-B30G

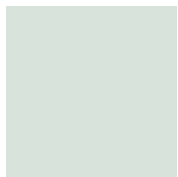

15110-1515 € CC12

M₃ plain mint green
 c2c 47 NCS S 3005-G20Y



15120-1515 € CC12

M₃ plain Prussian blue
 c2c 15 NCS S 6020-R90B



15130-1515 € CC12

M₃ plain Sèvres blue
 c2c 40 NCS S 2020-R90B

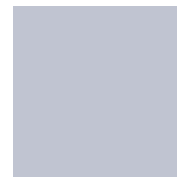

15150-1515 € CC12

M₃ plain dove blue
 c2c 39 NCS S 4005-R80B



15180-1515 € CC12

M₃ plain light oxide red
 c2c 30 NCS S 4020-Y70R



15200-1515 € CC12

M₃ plain ivory black
 10 15 30
 c2c 10 NCS S 8000-N

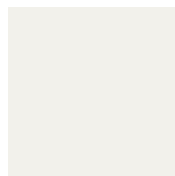

15210-1515 € CC12

M₃ plain white unbleached
 10 15 30
 c2c 68 NCS S 1005-Y10R

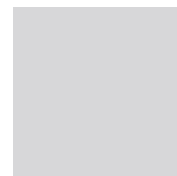

15220-1515 € CC12

M₃ plain grey
 10 15 30
 c2c 44 NCS S 3000-N



15230-1515 € CC12

M₃ plain mouse grey
 10 15 30
 c2c 27 NCS S 5500-N



15240-1515 € CC12

M₃ plain black
 10 15 30
 c2c 5 NCS S 9000-N



25240-1515 € CC12

M₃ plain warm grey
 10 15 30
 c2c 16 NCS S 7005-Y20R





25250-1515 € CC12

M₃ plain anthracite
 10 15 30
 c2c 16 NCS S 6500-N

1515 Global Collection





wandtegels / carreaux de faïence / Wandfliesen / wall tiles
 geglaazuurd / émaillé / glasiert / glazed
 niet vorstbestand / non ingélif / nicht frostsicher / not frost proof

bijpassende vloertegels / carreaux de sol correspondants /
 dazugehörige Bodenfliesen / matching floor tiles
 Global Collection   

no.	mm	inch	pieces/ m ²	pieces/ m ¹	pieces/ box	boxes/ pallet	pieces/ pallet	m ² / pallet	kg/ m ²	kg/ pallet
25260 - 15990	147x147x5,6	5.79x5.79x0.22	44	-	44 = 1,00 m ²	100	4.400	100,0	9,2	940





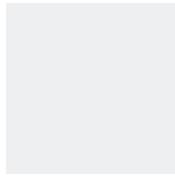

25260-1515  CC12

 plain Sienna red
   S 5030-Y70R





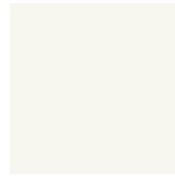

25270-1515  CC12

 plain white grey
    S 1505-Y90R





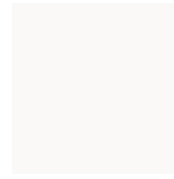

15800-1515  CC12

 plain white unbleached
    S 1005-Y10R





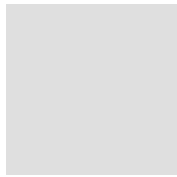

15810-1515  CC12

 plain accent white
    S 1002-Y50R







15820-1515  CC12

 plain grey
    S 2502-Y80R







15830-1515  CC12

 plain mouse grey
    S 5000-N







15850-1515  CC12

 plain agate grey
    S 5005-Y50R







15890-1515  CC12

 plain ivory black
    S 8000-N







15960-1515  CC12

 plain warm grey
    S 6502-R





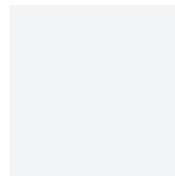

15970-1515  CC12

 plain anthracite
    S 6500-N







15980-1515  CC12

 plain white grey
    S 1505-Y90R



15990-1515  CC12

 plain light warm grey
    S 2005-Y50R

1515 Murals Blend

wandtegels / carreaux de faïence / Wandfliesen / wall tiles
 geglaazuurd / émaillé / glasiert / glazed
 niet vorstbestand / non ingélif / nicht frostsicher / not frost proof

no.	mm	inch	pieces/ m ²	pieces/ m ¹	pieces/ box	boxes/ pallet	pieces/ pallet	m ² / pallet	kg/ m ²	kg/ pallet
30510 - 32030	147x147x7	5.79x5.79x0.28	44	-	33 = 0,75 m ²	115	3.795	86,3	11,7	1.038

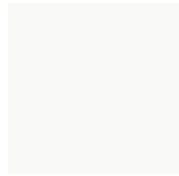

30510-1515 € CC08

bright white
 85 S 0300-N GL

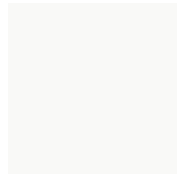

30010-1515 € CC08

bright white
 83 S 0300-N

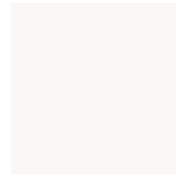

30520-1515 € CC08

light cool grey #1
 80 S 0502-R50B GL

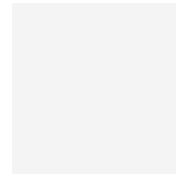

30030-1515 € CC08

light cool grey #2
 76 S 0502-R50B

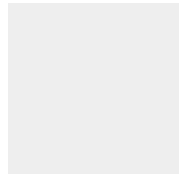

30540-1515 € CC08

light cool grey #3
 73 S 1002-R50B GL

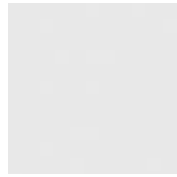

30050-1515 € CC08

light cool grey #4
 67 S 1002-R50B



30560-1515 € CC08

mid warm grey #1
 45 S 2005-Y50R GL



30070-1515 € CC08

mid warm grey #2
 40 S 3005-Y50R



30580-1515 € CC08

mid warm grey #3
 37 S 3005-Y50R GL



30090-1515 € CC08

mid warm grey #4
 31 S 4005-Y50R



30600-1515 € CC08

dark anthracite #1
 14 S 7000-N GL



30110-1515 € CC08

dark anthracite #2
 12 S 7000-N



30620-1515 € CC08

dark anthracite #3
 12 S 7500-N GL



30130-1515 € CC08

dark anthracite #4
 9 S 8000-N

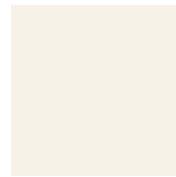

32010-1515 € CC08

clay beige #1
 75 S 0502-Y50R

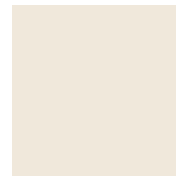

32030-1515 € CC08

clay beige #3
 65 S 1005-Y30R

15 15 Murals Blend

wandtegels / carreaux de faïence / Wandfliesen / wall tiles
 geglazuurd / émaillé / glasiert / glazed
 niet vorstbestand / non ingélif / nicht frostsicher / not frost proof

no.	mm	inch	pieces/ m ²	pieces/ m ¹	pieces/ box	boxes/ pallet	pieces/ pallet	m ² / pallet	kg/ m ²	kg/ pallet
32250 - 32130	147x147x7	5.79x5.79x0.28	44	-	33 = 0,75 m ²	115	3.795	86,3	11,7	1.038



32250-1515 € CC08

M2 silver grey #1
 c2c 58 NGS S 1500-N



32270-1515 € CC08

M2 silver grey #3
 c2c 47 NGS S 2500-N

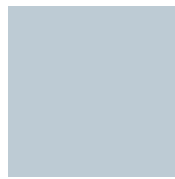

32110-1515 € CC08

M2 air blue #1
 c2c 55 NGS S 2010-R90B



32090-1515 € CC08

M2 sea blue #1
 c2c 21 NGS S 5010-R70B



32290-1515 € CC08

M2 ocean green #1
 c2c 70 NGS S 1005-G20Y



32130-1515 € CC08

M2 wood green #1
 c2c 24 NGS S 5005-G80Y

1515 Murals Change

wandtegels / carreaux de faïence / Wandfliesen / wall tiles
 geglaazuurd / émaillé / glasiert / glazed
 niet vorstbestand / non ingélif / nicht frostsicher / not frost proof

no.	mm	inch	pieces/ m ²	pieces/ m ¹	pieces/ box	boxes/ pallet	pieces/ pallet	m ² / pallet	kg/ m ²	kg/ pallet
34510 - 34580	147x147x7	5.79x5.79x0.28	44	-	33 = 0,75 m ²	115	3.795	86,3	11,9	1.053



34510-1515 € AC32

M2 ✈ bright white / bright white



C2G ✈ 83 / 85 NCS S 0300-N / S 0300-N-GL



34530-1515 € AC32

M2 ✈ mid warm grey #1 / #3



44 / 37 NCS S 2005-Y50R / S 3005-Y50R GL



34580-1515 € AC32

M2 ✈ ocean green #1 / #1



70 / 69 NCS S 1005-G20Y / S 1005-B80G GL

1515 Murals Fuse

wandtegels / carreaux de faïence / Wandfliesen / wall tiles
 geglazuurd / émaillé / glasiert / glazed
 niet vorstbestand / non ingélif / nicht frostsicher / not frost proof

no.	mm	inch	pieces/ m ²	pieces/ m ¹	pieces/ box	boxes/ pallet	pieces/ pallet	m ² / pallet	kg/ m ²	kg/ pallet
38010 - 38070	147x147x7	5.79x5.79x0.28	44	-	33 = 0,75 m ²	115	3.795	86,3	11,7	1.038

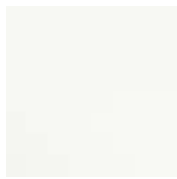

38010-1515 € BC04

M2 bright white
 15 30 30
 c2c 80 NCS S 0300-N

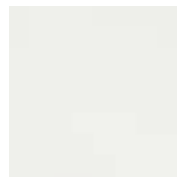

38510-1515 € BC04

M2 bright white
 15 30 30
 c2c 81 NCS S 0300-N GL



38520-1515 € BC04

M2 light cool grey #4
 15 30 30
 c2c 66 NCS S 1002-R50B GL

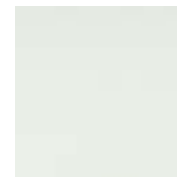

38530-1515 € BC04

M2 ocean green #1
 15 30 30
 c2c 67 NCS S 1005-G20Y GL



38040-1515 € BC04

M2 sea blue #1
 15 30 30
 c2c 22 NCS S 5010-R70B



38050-1515 € BC04

M2 mid warm grey #1
 15 30 30
 c2c 48 NCS S 2005-Y50R



38070-1515 € BC04

M2 dark anthracite #3
 15 30 30
 c2c 10 NCS S 7500-N

Deze tegels hebben een patroon met een kleurverloop.
 Ces carreaux créent un motif particulier où les couleurs se succèdent.
 Diese Fliesen haben ein Muster mit einem Farbverlauf.
 These tiles have a pattern with a colour gradation.

1515 Murals Lines

wandtegels / carreaux de faïence / Wandfliesen / wall tiles
 geglazuurd / émaillé / glasiert / glazed
 niet vorstbestand / non ingélif / nicht frostsicher / not frost proof

no.	mm	inch	pieces/ m ²	pieces/ m ¹	pieces/ box	boxes/ pallet	pieces/ pallet	m ² / pallet	kg/ m ²	kg/ pallet
36010 - 36020	147x147x7	5.79x5.79x0.28	44	-	29 = 0,659 m ²	115	3.335	75,8	12,0	932



36010-1515 € AC03

M2 bright white



c2c 83 NCS S 0300-N



36510-1515 € AC03

M2 bright white



c2c 85 NCS S0300-N GL



36030-1515 € AC03

M2 sea blue #1



c2c 21 NCS S 5010-R70B



36020-1515 € AC03

M2 mid warm grey #4



c2c 31 NCS S 4005-Y50R

15 20 Holland 2050

wandtegels / carreaux de faïence / Wandfliesen / wall tiles
 geplazuurd / émaillé / glasiert / glazed
 niet vorstbestand / non ingélif / nicht frostsicher / not frost proof

bijpassende vloertegels / carreaux de sol correspondants /
 dazugehörnde Bodenfliesen / matching floor tiles
 Holland 2050 

no.	mm	inch	pieces/ m ²	pieces/ m ¹	pieces/ box	boxes/ pallet	pieces/ pallet	m ² / pallet	kg/ m ²	kg/ pallet
0490 - 17070	147x197x5,3	5.79x7.76x0.21	33	-	41 = 1,242 m ²	100	4.100	124,0	9,0	1.140

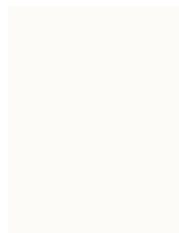

0490-1520



 wit / blanc / weiß / white



  81  S 0603-Y80R GL

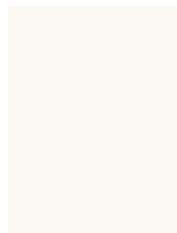

0497-1520



 roomwit / crème-blanc /
rahm-weiß / cream-white



  79  S 0804-Y70R GL

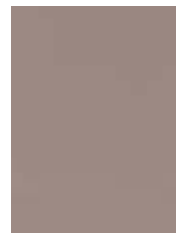

13740-1520



 midden warm grijs /
gris chaleureux moyen /
mittel warm grau / mid warm grey



  28  S 5005-Y50R GL

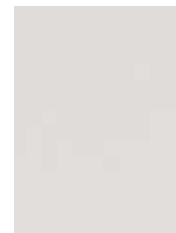

16870-1520



 grijs uni / gris uni /
grau Uni / plain grey



  51  S 2500-N GL

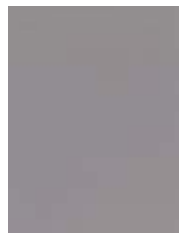

16890-1520



 donkergrijs / gris foncé /
dunkelgrau / dark grey



  26  S 5500-N GL



17050-1520



 licht antraciet / anthracite clair /
hell anthrazit / light anthracite



  14  S 7000-N GL

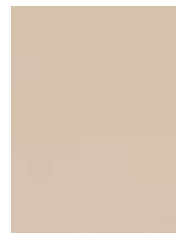

17060-1520



 beige / beige /
beige / beige



  50  S 2005-Y40R GL



17070-1520







 grijsbruin / gris-brun /
graubraun / grey brown



  20  S 6005-Y80R GL

1530 15thirty Accent

wandtegels / carreaux de faïence / Wandfliesen / wall tiles
 geglaazuurd / émaillé / glasiert / glazed
 niet vorstbestand / non ingélif / nicht frostsicher / not frost proof



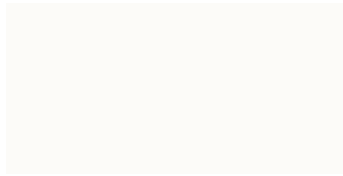

bijpassende vloertegels / carreaux de sol correspondants /
 dazugehörnde Bodenfliesen / matching floor tiles
 Core Collection Terra, nos. 203, 204, 216, 225, 226, 264, 266   
 Softline, nos. 74020, 74030, 74090 
 Softgrip, nos. 74020, 74030, 74090 

no.	mm	inch	pieces/ m ²	pieces/ m ¹	pieces/ box	boxes/ pallet	pieces/ pallet	m ² / pallet	kg/ m ²	kg/ pallet
0460 - 17090	147x297x7	5.79x11.69x0.28	22	-	21 = 0,955 m ²	80	1.680	76,4	11,6	910

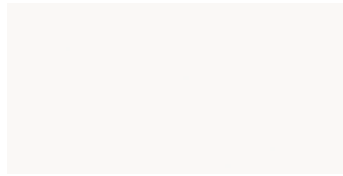







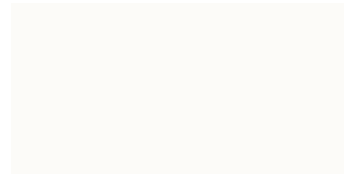

0460-1530   **U01**
 koel wit / blanc frais /
 kühl weiß / cool white
    S 0502-R50B GL







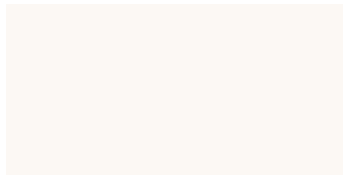

0465-1530   **U01**
 koel wit / blanc frais /
 kühl weiß / cool white
  







0495-1530   **U01**
 wit / blanc /
 weiß / white
   
 

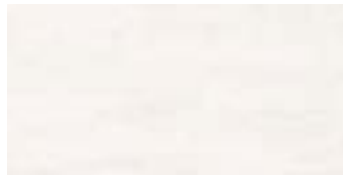





0498-1530   **U01**
 roomwit / crème-blanc /
 rahm-weiß / cream-white
  
 



13810-1530   **U2**
 wit-grijs / blanc-gris /
 weiß-grau / white-grey
 



13830-1530   **U2**
 wit-beige / blanc-beige /
 weiß-beige / white-beige
 

1530 Global Collection

wandtegels / carreaux de faïence / Wandfliesen / wall tiles
 geglaazuurd / émaillé / glasiert / glazed
 niet vorstbestand / non ingélif / nicht frostsicher / not frost proof

bijpassende vloertegels / carreaux de sol correspondants /
 dazugehörige Bodenfliesen / matching floor tiles
 Global Collection 10 15 30

no.	mm	inch	pieces/ m ²	pieces/ m ¹	pieces/ box	boxes/ pallet	pieces/ pallet	m ² / pallet	kg/ m ²	kg/ pallet
13100 - 16740	147x297x7	5.79x11.69x0.28	22	-	21 = 0,955 m ²	80	1.680	76,4	11,6	910

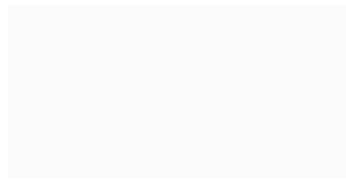

13100-1530 € BC06

plain white
 69 S 0603-R40B GL



13730-1530 € BC06

plain light warm grey
 39 S 2005-Y50R GL

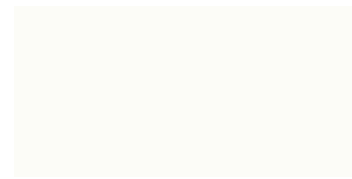

16610-1530 € BC06

plain cream-white
 84 S 0502-Y GL

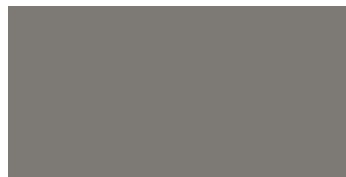

16650-1530 € BC06

plain agate grey
 25 S 5005-Y50R GL

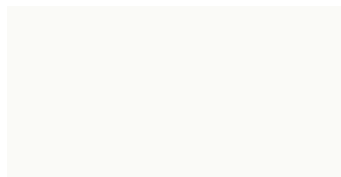

16660-1530 € BC06

plain ivory white
 82 S 0505-Y10R GL



16670-1530 € BC06

plain Naples yellow
 52 S 2030-Y20R GL



16680-1530 € BC06

plain sand yellow
 64 S 2020-Y20R GL

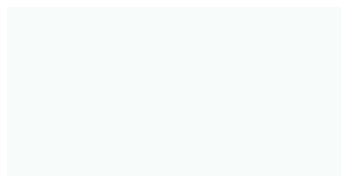

16690-1530 € BC06

plain pearl green
 80 S 0505-G20Y GL



16700-1530 € BC06

plain olive green
 36 S 3020-G20Y GL



16720-1530 € BC06

plain turquoise
 23 S 6020-B30G GL

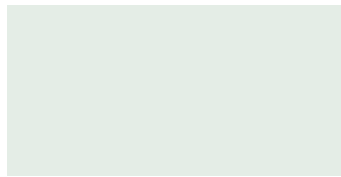

16730-1530 € BC06

plain mint green
 62 S 1005-G20Y GL



16740-1530 € BC06

plain pearl blue
 80 S 0505-R90B GL

1530 Global Collection

wandtegels / carreaux de faïence / Wandfliesen / wall tiles
 geglaazuurd / émaillé / glasiert / glazed
 niet vorstbestand / non ingélf / nicht frostsicher / not frost proof

bijpassende vloertegels / carreaux de sol correspondants /
 dazugehörige Bodenfliesen / matching floor tiles
 Global Collection 18 19 15

no.	mm	inch	pieces/ m ²	pieces/ m ¹	pieces/ box	boxes/ pallet	pieces/ pallet	m ² / pallet	kg/ m ²	kg/ pallet
16750 - 16910	147x297x7	5.79x11.69x0.28	22	-	21 = 0,955 m ²	80	1.680	76,4	11,6	910



16750-1530 € BC06

plain Prussian blue
 18 19 15
 c2c 19 NCS S 6020-R90B GL



16760-1530 € BC06

plain Sèvres blue
 18 19 15
 c2c 54 NCS S 2020-R90B GL

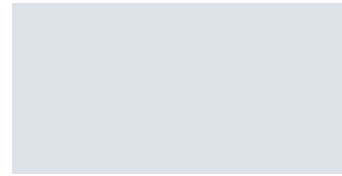

16780-1530 € BC06

plain dove blue
 18 19 15
 c2c 51 NCS S 4005-R80B GL

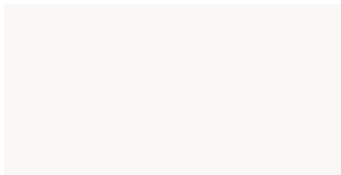

16790-1530 € BC06

plain ivory
 18
 c2c 78 NCS S 1010-Y30R GL



16820-1530 € BC06

plain light oxide red
 18 19 15
 c2c 32 NCS S 4020-Y70R GL

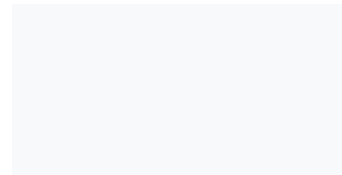

16840-1530 € BC06

plain cool white
 18
 c2c 78 NCS S 1002-R50B GL



16850-1530 € BC06

plain ivory black
 18 19 15
 c2c 12 NCS S 8000-N GL

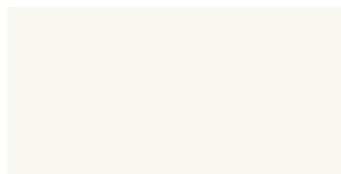

16860-1530 € BC06

plain white unbleached
 18 19 15
 c2c 78 NCS S 1005-Y10R GL

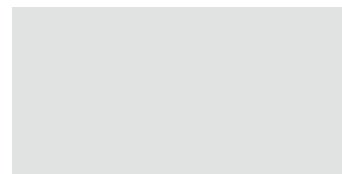

16870-1530 2050 € BC06

plain grey
 18 19 15
 c2c 51 NCS S 3000-N GL



16880-1530 € BC06

plain mouse grey
 18 19 15
 c2c 27 NCS S 5500-N GL

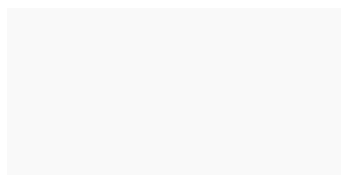

16900-1530 € BC06

plain accent white
 18 19 15
 c2c 85 NCS S 0502-R50B GL

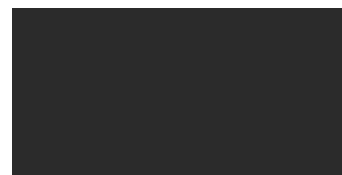

16910-1530 € BC06

plain black
 18 19 15
 c2c 5 NCS S 9000-N GL

1530 Global Collection

wandtegels / carreaux de faïence / Wandfliesen / wall tiles
 geglazuurd / émaillé / glasiert / glazed
 niet vorstbestand / non ingélif / nicht frostsicher / not frost proof

bijpassende vloertegels / carreaux de sol correspondants /
 dazugehörige Bodenfliesen / matching floor tiles
 Global Collection 

no.	mm	inch	pieces/ m ²	pieces/ m ¹	pieces/ box	boxes/ pallet	pieces/ pallet	m ² / pallet	kg/ m ²	kg/ pallet
26240 - 15230	147x297x7	5.79x11.69x0.28	22	-	21 = 0,955 m ²	80	1.680	76,4	11,6	910







26240-1530 

 plain warm grey

  15  S 7005-Y20R GL







26250-1530 

 plain anthracite

  16  S 6500-N GL





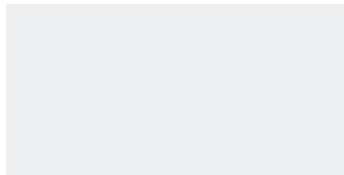

26260-1530 

 plain Sienna red

  13  S 5030-Y70R GL





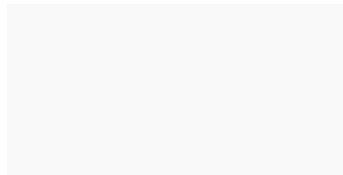

26270-1530 

 plain white grey

  48  S 1505-Y90R GL





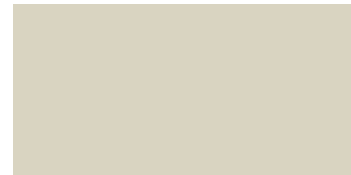

13000-1530 

 plain white

  73  S0603-R40B





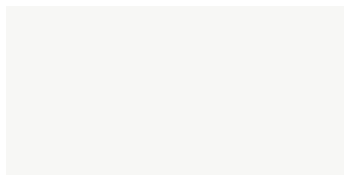

13630-1530 

 plain light warm grey

  32  S 2005-Y50R







15010-1530 

 plain accent white

  78  S 1002-Y50R







15050-1530 

 plain agate grey

  24  S 5005-Y50R





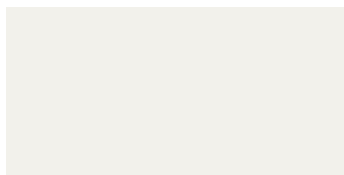

15200-1530  

 plain ivory black

  10  S 8000-N





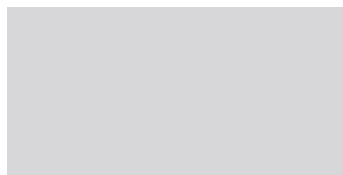

15210-1530  

 plain white unbleached

  68  S 1005-Y10R







15220-1530  

 plain grey

  44  S 3000-N



15230-1530 

 plain mouse grey

  27  S 5500-N

1530 Global Collection

wandtegels / carreaux de faïence / Wandfliesen / wall tiles
 geglaazuurd / émaillé / glasiert / glazed
 niet vorstbestand / non ingélif / nicht frostsicher / not frost proof

bijpassende vloertegels / carreaux de sol correspondants /
 dazugehörnde Bodenfliesen / matching floor tiles
 Global Collection 18 19 20

no.	mm	inch	pieces/ m ²	pieces/ m ¹	pieces/ box	boxes/ pallet	pieces/ pallet	m ² / pallet	kg/ m ²	kg/ pallet
15240 - 25270	147x297x7	5.79x11.69x0.28	22	-	21 = 0,955 m ²	80	1.680	76,4	11,6	910



15240-1530 € BC06

M3 plain black



c2c 5 NCS S 9000-N



25240-1530 € BC06

M3 plain warm grey



c2c 16 NCS S 7005-Y20R



25250-1530 € BC06

M3 plain anthracite



c2c 16 NCS S 6500-N

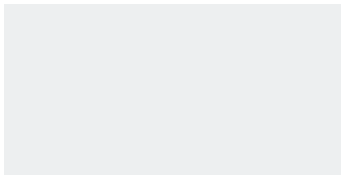

25270-1530 € BC06

M3 plain white grey



c2c 47 NCS S 1505-Y90R

15/30 Holland 2050

wandtegels / carreaux de faïence / Wandfliesen / wall tiles
 geglaazuurd / émaillé / glasiert / glazed
 niet vorstbestand / non ingélif / nicht frostsicher / not frost proof

bijpassende vloertegels / carreaux de sol correspondants /
 dazugehörige Bodenfliesen / matching floor tiles
 Holland 2050 

no.	mm	inch	pieces/ m ²	pieces/ m ¹	pieces/ box	boxes/ pallet	pieces/ pallet	m ² / pallet	kg/ m ²	kg/ pallet
0490 - 17070	147x297x7	5.79x11.69x0.28	22	-	21 = 0,955 m ²	80	1.680	76,4	11,6	910

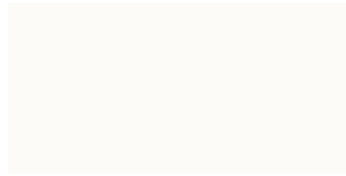

0490-1530   U01

 wit / blanc /
weiß / white



  81  S 0603-Y80R GL

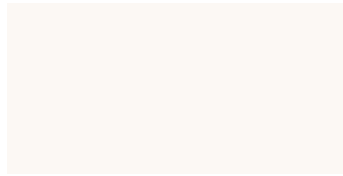

0497-1530   U01

 roomwit / crème-blanc /
rahm-weiß / cream-white



  79  S 0804-Y70R GL



13740-1530   U1

 midden warm grijs / gris chaleureux moyen /
mittel warm grau / mid warm grey



  28  S 5005-Y50R GL



16870-1530   U1

 grijs / gris /
grau / grey



  51  S 2500-N GL



16890-1530   U1

 donkergrijs / gris foncé /
dunkelgrau / dark grey



  26  S 5500-N GL



17050-1530   U1

 licht antraciet / anthracite clair /
hell anthrazit / light anthracite



  14  S 7000-N GL



17060-1530   U1

 beige / beige /
beige / beige



  50  S 2005-Y40R GL



17070-1530   U1

 grijsbruin / gris-brun /
graubraun / grey brown



  20  S 6005-Y80R GL

15/30 Murals Blend

wandtegels / carreaux de faïence / Wandfliesen / wall tiles
 geglazuurd / émaillé / glasiert / glazed
 niet vorstbestand / non ingélif / nicht frostsicher / not frost proof

no.	mm	inch	pieces/ m ²	pieces/ m ¹	pieces/ box	boxes/ pallet	pieces/ pallet	m ² / pallet	kg/ m ²	kg/ pallet
30010 - 30610	147x297x7	5.79x11.69x0.28	22	-	21 = 0,955 m ²	80	1.680	76,4	12,0	939

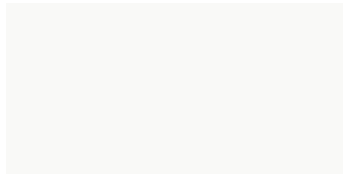

30010-1530 € CC08

M₂ bright white
 83 NCS S 0300-N

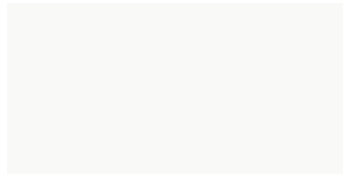

30510-1530 € CC08

M₂ bright white
 85 NCS S 0300-N GL

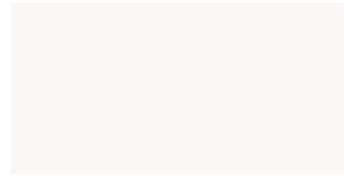

30020-1530 € CC08

M₂ light cool grey #1
 81 NCS S 0502-R50B

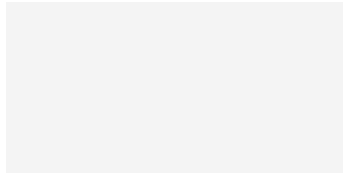

30530-1530 € CC08

M₂ light cool grey #2
 78 NCS S 0502-R50B GL

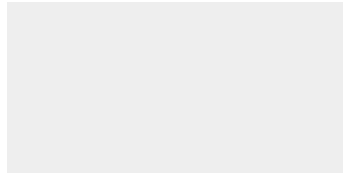

30040-1530 € CC08

M₂ light cool grey #3
 72 NCS S 1002-R50B

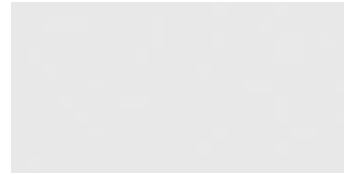

30550-1530 € CC08

M₂ light cool grey #4
 70 NCS S 1002-R50B GL



30060-1530 € CC08

M₂ mid warm grey #1
 44 NCS S 2005-Y50R



30570-1530 € CC08

M₂ mid warm grey #2
 40 NCS S 3005-Y50R GL



30080-1530 € CC08

M₂ mid warm grey #3
 36 NCS S 3005-Y50R



30590-1530 € CC08

M₂ mid warm grey #4
 32 NCS S 4005-Y50R GL



30100-1530 € CC08

M₂ dark anthracite #1
 13 NCS S 7000-N



30610-1530 € CC08

M₂ dark anthracite #2
 13 NCS S 7000-N GL

15 30 Murals Blend

wandtegels / carreaux de faïence / Wandfliesen / wall tiles
 geglaazuurd / émaillé / glasiert / glazed
 niet vorstbestand / non ingélif / nicht frostsicher / not frost proof

no.	mm	inch	pieces/ m ²	pieces/ m ¹	pieces/ box	boxes/ pallet	pieces/ pallet	m ² / pallet	kg/ m ²	kg/ pallet
30120 - 32240	147x297x7	5.79x11.69x0.28	22	-	21 = 0,955 m ²	80	1.680	76,4	12,0	939



30120-1530 € CC08

M2 dark anthracite #3
 c2c 10 NGS S 7500-N



30630-1530 € CC08

M2 dark anthracite #4
 c2c 10 NGS S 8000-N GL

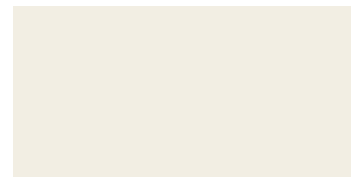

32020-1530 € CC08

M2 clay beige #2
 c2c 71 NGS S 1002-Y50R

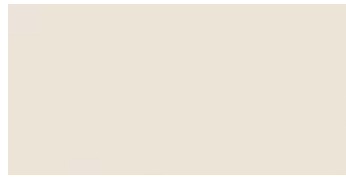

32040-1530 € CC08

M2 clay beige #4
 c2c 62 NGS S 1505-Y40R



32260-1530 € CC08

M2 silver grey #2
 c2c 52 NGS S 2000-N



32280-1530 € CC08

M2 silver grey #4
 c2c 43 NGS S 3000-N



32120-1530 € CC08

M2 air blue #2
 c2c 43 NGS S 3005-R80B



32100-1530 € CC08

M2 sea blue #2
 c2c 14 NGS S 6010-R70B



32300-1530 € CC08

M2 ocean green #2
 c2c 58 NGS S 1010-G20Y



32140-1530 € CC08

M2 wood green #2
 c2c 16 NGS S 7005-G80Y



32320-1530 € CC08

M2 oxide red #2
 c2c 21 NGS S 5020-Y70R



32180-1530 € CC08

M2 earth brown #2
 c2c 10 NGS S 7005-Y20R

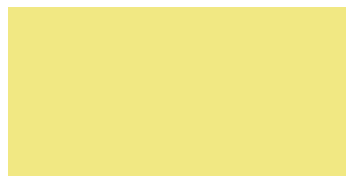

32200-1530 € CC08

M2 brimstone yellow #2
 c2c 71 NGS S 1040-G80Y



32240-1530 € CC08

M2 brass brown #2
 c2c 24 NGS S 5030-Y

15 30 Murals Change

wandtegels / carreaux de faïence / Wandfliesen / wall tiles
 geglazuurd / émaillé / glasiert / glazed
 niet vorstbestand / non ingélif / nicht frostsicher / not frost proof

no.	mm	inch	pieces/ m ²	pieces/ m ¹	pieces/ box	boxes/ pallet	pieces/ pallet	m ² / pallet	kg/ m ²	kg/ pallet
34510 - 34550	147x297x7	5.79x11.69x0.28	22	-	21 = 0,955 m ²	80	1.680	76,4	12,4	969



34510-1530 € AC31
 M2 ✈ bright white / bright white
 15 30
 c2c ✈ 83 / 85 NCS S 0300-N / S 0300-N GL



34040-1530 € AC31
 M2 M2 clay beige #2 / #1
 c2c ✈ 71 / 75 NCS S 1002-Y50R / S 0502-Y50R



34550-1530 € AC31
 M2 ✈ dark anthracite #4 / #4
 c2c ✈ 9 / 10 NCS S 8000-N / S 8000-N GL



1530 Murals Fuse

wandtegels / carreaux de faïence / Wandfliesen / wall tiles
 geglaazuurd / émaillé / glasiert / glazed
 niet vorstbestand / non ingélif / nicht frostsicher / not frost proof

no.	mm	inch	pieces/ m ²	pieces/ m ¹	pieces/ box	boxes/ pallet	pieces/ pallet	m ² / pallet	kg/ m ²	kg/ pallet
38010 - 38070	147x297x7	5.79x11.69x0.28	22	-	21 = 0,955 m ²	80	1.680	76,4	12,0	939





38010-1530 € BC04

M2 bright white

 80 NCS S 0300-N





38510-1530 € BC04

M2 bright white

 81 NCS S 0300-N GL





38520-1530 € BC04

M2 light cool grey #4

 66 NCS S 1002-R50B GL





38530-1530 € BC04

M2 ocean green #1

 67 NCS S 1005-G20Y GL





38040-1530 € BC04

M2 sea blue #1

 22 NCS S 5010-R70B



38050-1530 € BC04

M2 mid warm grey #1

 48 NCS S 2005-Y50R



38060-1530 € BC04

M2 brass brown #1

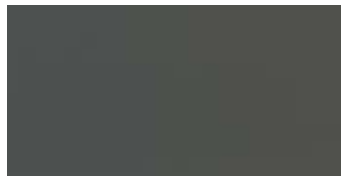
 32 NCS S 3030-Y



38070-1530 € BC04

M2 dark anthracite #3

 10 NCS S 7500-N

Deze tegels hebben een patroon met een kleurverloop.
 Ces carreaux créent un motif particulier où les couleurs se succèdent.
 Diese Fliesen haben ein Muster mit einem Farbverlauf.
 These tiles have a pattern with a colour gradation.

15 30 Murals Lines

wandtegels / carreaux de faïence / Wandfliesen / wall tiles
 geglazuurd / émaillé / glasiert / glazed
 niet vorstbestand / non ingélif / nicht frostsicher / not frost proof

no.	mm	inch	pieces/ m ²	pieces/ m ¹	pieces/ box	boxes/ pallet	pieces/ pallet	m ² / pallet	kg/ m ²	kg/ pallet
36010 - 36050	147x297x7	5.79x11.69x0.28	22	-	18 = 0,818 m ²	80	1.440	65,5	12,6	847



36010-1530 AC02

bright white



S 0300-N



36510-1530 AC02

bright white



S 0300-N GL



36080-1530 AC02

silver grey #1



S 1500-N



36050-1530 AC02

dark anthracite #1



S 7000-N

2025 Holland 2050

wandtegels / carreaux de faïence / Wandfliesen / wall tiles
 geglaazuurd / émaillé / glasiert / glazed
 niet vorstbestand / non ingélif / nicht frostsicher / not frost proof

bijpassende vloertegels / carreaux de sol correspondants /
 dazugehörige Bodenfliesen / matching floor tiles
 Holland 2050 

no.	mm	inch	pieces/ m ²	pieces/ m ¹	pieces/ box	boxes/ pallet	pieces/ pallet	m ² / pallet	kg/ m ²	kg/ pallet
0490 - 17070	197x247x7,4	7.76x9.72x0.29	20	-	20 = 1,00 m ²	84	1.680	84,0	12,6	1.080

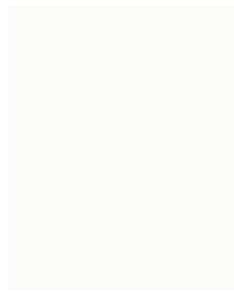

0490-2025



 wit / blanc /
weiß / white

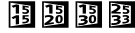

  81  S 0603-Y80R GL

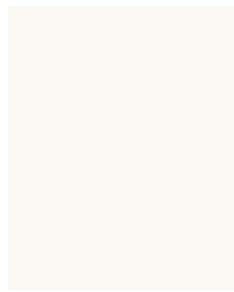

0497-2025



 roomwit / crème-blanc /
rahm-weiß / cream-white



  79  S 0804-Y70R GL



13740-2025



 midden warm grijs /
gris chaleureux moyen /
mittel warm grau / mid warm grey



  28  S 5005-Y50R GL



16870-2025



 grijs uni / gris uni /
grau Uni / plain grey

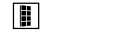

  51  S 2500-N GL



16890-2025



 donkergrijs / gris foncé /
dunkelgrau / dark grey



  26  S 5500-N GL



17050-2025



 licht antraciet / anthracite clair /
hell anthrazit / light anthracite



  14  S 7000-N GL

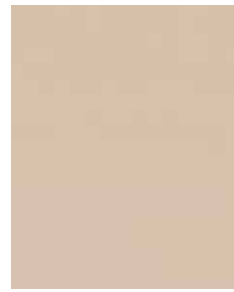

17060-2025



 beige / beige /
beige / beige



  50  S 2005-Y40R GL



17070-2025



 grijsbruin / gris-brun /
graubraun / grey brown







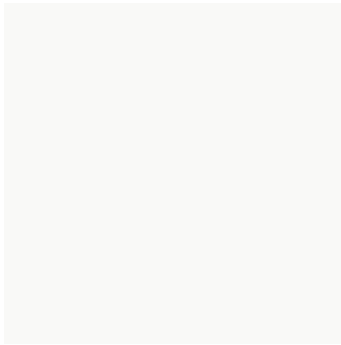

  20  S 6005-Y80R GL

3030 Murals Blend





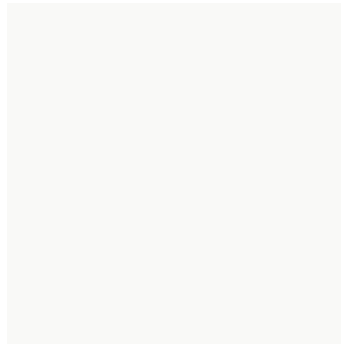

wandtegels / carreaux de faïence / Wandfliesen / wall tiles
 geglazuurd / émaillé / glasiert / glazed
 niet vorstbestand / non ingélif / nicht frostsicher / not frost proof

no.	mm	inch	pieces/ m ²	pieces/ m ¹	pieces/ box	boxes/ pallet	pieces/ pallet	m ² / pallet	kg/ m ²	kg/ pallet
30510 - 30010	297x297x7	11.69x11.69x0.28	11	-	10 = 0,909 m ²	68	680	61,8	11,7	749



30510-3030  CC08
 bright white

   S 0300-N GL



30010-3030  CC08
 bright white

   S 0300-N

3030 Murals Fuse

wandtegels / carreaux de faïence / Wandfliesen / wall tiles
 geglaazuurd / émaillé / glasiert / glazed
 niet vorstbestand / non ingélif / nicht frostsicher / not frost proof

no.	mm	inch	pieces/ m ²	pieces/ m ¹	pieces/ box	boxes/ pallet	pieces/ pallet	m ² / pallet	kg/ m ²	kg/ pallet
38010 - 38070	297x297x7	11.69x11.69x0.28	11	-	10 = 0,909 m ²	68	680	61,8	11,7	749



38010-3030 BC04
 M2 bright white
 15 30
 c2c NCS S 0300-N

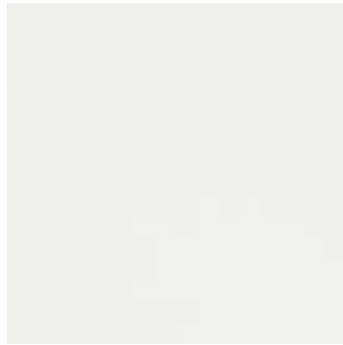

38510-3030 BC04
 M2 bright white
 15 30
 c2c NCS S 0300-N GL



38520-3030 BC04
 M2 light cool grey #4
 15 30
 c2c NCS S 1002-R50B GL



38530-3030 BC04
 M2 ocean green #1
 15 30
 c2c NCS S 1005-G20Y GL



38040-3030 BC04
 M2 sea blue #1
 15 30
 c2c NCS S 5010-R70B



38050-3030 BC04
 M2 mid warm grey #1
 15 30
 c2c NCS S 2005-Y50R



38070-3030 BC04
 M2 dark anthracite #3
 15 30
 c2c NCS S 7500-N

Deze tegels hebben een patroon met een kleurverloop.
 Ces carreaux créent un motif particulier où les
 couleurs se succèdent.
 Diese Fliesen haben ein Muster mit einem Farbverlauf.
 These tiles have a pattern with a colour gradation.

3060 Murals Blend

wandtegels / carreaux de faïence / Wandfliesen / wall tiles
 geglaazuurd / émaillé / glasiert / glazed
 niet vorstbestand / non ingélif / nicht frostsicher / not frost proof

no.	mm	inch	pieces/ m ²	pieces/ m ¹	pieces/ box	boxes/ pallet	pieces/ pallet	m ² / pallet	kg/ m ²	kg/ pallet
31510 - 31070	297x597x8,1	11.69x23.50x0.32	5,56	-	7 = 1,259 m ²	40	280	50,4	13,6	710

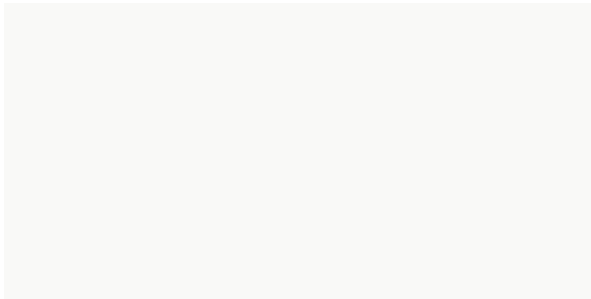

31510-3060-A CC07

bright white
 85 S 0300-N GL

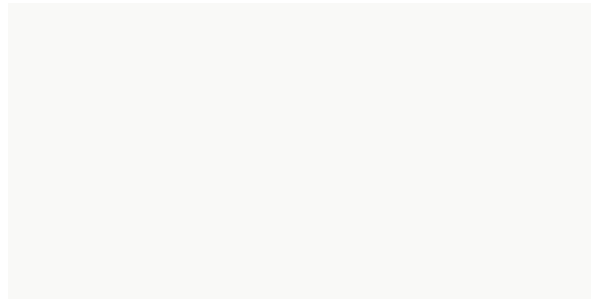

31010-3060-A CC07

bright white
 83 S 0300-N

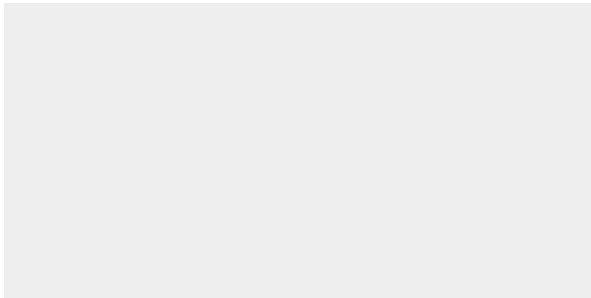

31540-3060-A CC07

light cool grey #3
 73 S 1002-R50B GL

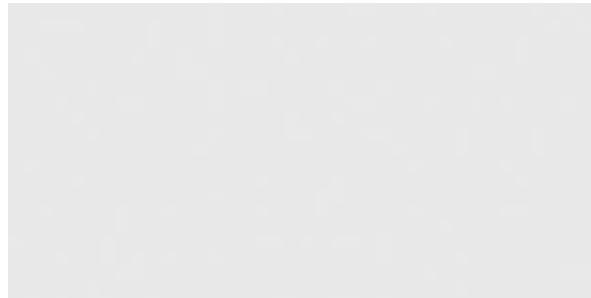

31050-3060-A CC07

light cool grey #4
 67 S 1002-R50B



31560-3060-A CC07

mid warm grey #1
 45 S 2005-Y50R GL



31070-3060-A CC07

mid warm grey #2
 40 S 3005-Y50R





3060 Murals Blend

wandtegels / carreaux de faïence / Wandfliesen / wall tiles
 geglaazuurd / émaillé / glasiert / glazed
 niet vorstbestand / non ingélif / nicht frostsicher / not frost proof

no.	mm	inch	pieces/ m ²	pieces/ m ¹	pieces/ box	boxes/ pallet	pieces/ pallet	m ² / pallet	kg/ m ²	kg/ pallet
31620 - 31130	297x597x8,1	11.69x23.50x0.32	5,56	-	7 = 1,259 m ²	40	280	50,4	13,6	710







31620-3060-A  CC07

 dark anthracite #3
  12  S 7500-N GL



31130-3060-A  CC07











 dark anthracite #4
  9  S 8000-N

Voor tegelpatronen zie generator.mosa.com.
 Pour des motifs de carreaux, visitez generator.mosa.com.
 Für Verlegemuster siehe generator.mosa.com.
 For tile patterns see generator.mosa.com.

Mosa.

Floor tiles

Floor tiles

	Global Collection	77
	Core Collection Terra	79
	Global Collection	80
	Scenes	85
	Softline	87
	Core Collection Terra	89
	Global Collection	91
	Core Collection Solids	99
	Core Collection Terra	101
	Mosa Stage	105
	Terra Tones	107
	Core Collection Quartz	111
	Core Collection Solids	113
	Core Collection Terra	116
	Mosa Stage	124
	Terra Tones	125
	Core Collection Terra	131
	Core Collection Solids	137
	Core Collection Terra	139
	Mosa Stage	142
	Stroken / Listels / Streifen / Planks	
	Core Collection Solids	145
	Core Collection Terra	147
	Terra Tones	151
	Reliëftegels / Carreaux en relief / Relieffliesen / Relief tiles	
	Core Collection Quartz	155
	Core Collection Solids	157
	Core Collection Terra	159
	Holland 2050	164
	Scenes	165
	Global Collection	166
	Softgrip	168
	Accessoires / Accessoires / Formteile / Accessories	
	DP, DI, DU Global Collection, Scenes, Softline	169
	SP Scenes	170
	SP Core Collection Solids, Core Collection Terra	171
	VS, HS, VM, HM, VR, HR Globalgrip, Holland 2050, Softgrip, Core Collection Terra	172
	GL, GS Global Collection	174
	BN Global Collection	175
	BP Core Collection Quartz, Core Collection Solids, Core Collection Terra, Mosa Stage	176
	TVG Core Collection Solids, Core Collection Terra	177
	TCG Mosa Stage	178
	TSG Global Collection	179
	HV Core Collection Solids, Core Collection Terra	180

Let op: de getoonde vloertegels zijn geen exacte weergave van kleuren, structuren en formaten.
 Veuillez noter: les carreaux de sol affichés ne sont pas une représentation exacte des couleurs, textures et tailles.
 Bitte beachten Sie: Die angezeigten Bodenfliesen sind keine exakte Darstellung von Farben, Strukturen und Größen.
 Please note: the displayed floor tiles are not an exact representation of colors, textures, and sizes.

10 Global Collection

vloertegels / carreaux de sol / Bodenfliesen / floor tiles
 Ultragres ongeglazuurd / non émaillé / unglasiert / unglazed
 vorstbestand / ingélif / frostsicher / frost proof

bijpassende wandtegels / carreaux de faïence correspondants /
 dazugehörige Wandfliesen / matching wall tiles
 Global Collection

no.	mm	inch	pieces/ m ²	pieces/ m ¹	pieces/ box	boxes/ pallet	pieces/ pallet	m ² / pallet	kg/ m ²	kg/ pallet
75053V - 76243V	96x96x8	3.78x3.78x0.31	100	-	66 = 0,66 m ²	90	5.940	59,4	17,6	1.070



75053V1010 CP36

granulated clay grey
 DP, DI, DU

 R10 A
 S 4005-Y50R



75063V1010 CP36

granulated sun yellow
 DP, DI, DU

 R10 A
 S 3020-Y20R



75073V1010 CP36

granulated dune yellow
 DP, DI, DU

 R10 A
 S 3010-Y30R



75083V1010 CP36

granulated copper green
 DP, DI, DU

 R10 A
 S 5010-G10Y



75103V1010 CP36

granulated ivy green
 DP, DI, DU

 R10 A
 S 5010-B10G



75113V1010 CP36

granulated sage green
 DP, DI, DU

 R10 A
 S 3010-G40Y



75123V1010 CP36

granulated sapphire blue
 DP, DI, DU

 R10 A
 S 5020-R90B



75133V1010 CP36

granulated sky blue
 DP, DI, DU

 R10 A
 S 4010-R90B



75153V1010 CP36

granulated lavender blue
 DP, DI, DU

 R10 A
 S 4005-R80B



75183V1010 CP36

granulated pink red
 DP, DI, DU

 R10 A
 S 4010-Y90R



75203V1010 CP36

granulated stardust black
 DP, DI, DU, 75201GL, 75201GS

 R10 A
 S 7500-N



75213V1010 CP36

granulated eggshell beige
 DP, DI, DU

 R10 A
 S 2005-Y40R



75223V1010 CP36

granulated zinc grey
 DP, DI, DU

 R10 A
 S 4000-N



75233V1010 CP36

granulated slate grey
 DP, DI, DU

 R10 A
 S 4502-G

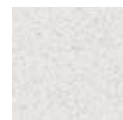

76013V1010 CP36

granulated crystal white
 DP, DI, DU, 75211GL, 75211GS

 R10 A
 S 1502-G50Y





76243V1010 CP36

granulated earth grey
 DP, DI, DU

 R10 A
 S 6005-Y80R

10 Global Collection

vloertegels / carreaux de sol / Bodenfliesen / floor tiles
 Ultragres ongeglazuurd / non émaillé / unglasiert / unglazed
 vorstbestand / ingélif / frostsicher / frost proof

bijpassende wandtegels / carreaux de faïence correspondants /
 dazugehörige Wandfliesen / matching wall tiles
 Global Collection   

no.	mm	inch	pieces/ m ²	pieces/ m ¹	pieces/ box	boxes/ pallet	pieces/ pallet	m ² / pallet	kg/ m ²	kg/ pallet
76253V - 76283V	96x96x8	3.78x3.78x0.31	100	-	66 = 0,66 m ²	90	5.940	59,4	17,6	1.070



76253V1010 

 granulated basalt grey

 DP, DI, DU



 R10  A

   S 5502-R50B



76263V1010 

 granulated cotto red

 DP, DI, DU



 R10  A

   S 5020-Y60R

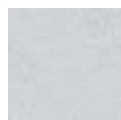

76273V1010 

 granulated silver grey

 DP, DI, DU



 R10  A

   S 2000-N



76283V1010 

 granulated sand grey

 DP, DI, DU



 R10  A

   S 3005-Y50R

















Core Collection Terra

vloertegels / carreaux de sol / Bodenfliesen / floor tiles
 Ultragres ongeglazuurd / non émaillé / unglasiert / unglazed
 vorstbestand / ingélif / frostsicher / frost proof

no.	mm	inch	pieces/ m ²	pieces/ m ¹	pieces/ box	boxes/ pallet	pieces/ pallet	m ² / pallet	kg/ m ²	kg/ pallet
203VV - 266VV	146x146x7,5	5.75x5.75x0.30	44	-	33 = 0,75 m ²	92	3.036	69,0	16,5	1.164



















203VV1515  € FH0

M cool black
 BP, 103VM, 103HM, TVG, HV
     
     
   









204VV1515  € FH0

M mid warm grey
 BP, 304SP, BP, 104VM, 104HM, TVG, HV
     
     
   



















206VV1515  FH0

M mid grey
 BP, 306SP, BP, TVG, HV
     
     
   











216VV1515  € FH0

M anthracite
 BP, 316SP, BP, 116VM, 116HM, TVG, HV
     
     
   



















225VV1515  € FH0

M light cool grey
 BP, 125VM, 125HM
     
     
   









226VV1515  € FH0

M mid cool grey
 BP, 126VM, 126HM, TVG, HV
     
     
   



















264VV1515  € FH0

M grey brown
 BP, 164VM, 164HM
     
     
   



266VV1515  € FH0

M light beige
 BP, 166VM, 166HM
     
     
   

15 Global Collection

vloertegels / carreaux de sol / Bodenfliesen / floor tiles
 Ultragres ongeglazuurd / non émaillé / unglasiert / unglazed
 vorstbestand / ingélif / frostsicher / frost proof

bijpassende wandtegels / carreaux de faïence correspondants /
 dazugehörige Wandfliesen / matching wall tiles
 Global Collection 30 43 33

no.	mm	inch	pieces/ m ²	pieces/ m ¹	pieces/ box	boxes/ pallet	pieces/ pallet	m ² / pallet	kg/ m ²	kg/ pallet
75055S - 75215S	146x146x7	5.75x5.75x0.28	44	-	33 = 0,75 m ²	92	3.036	69,0	15,3	1.082



75055S1515 € CP35

M flaked pumice grey
 DP, DI, DU, BN, LS
 30
 R10 B
 C2C 16 NCS S 65005-Y



75065S1515 € CP35

M flaked ochre yellow
 DP, DI, DU, BN
 30
 R10 B
 C2C 24 NCS S 4020-Y30R



75075S1515 € CP35

M flaked bronze yellow
 DP, DI, DU, BN, LS
 30
 R10 B
 C2C 29 NCS S 3020-Y40R



75085S1515 € CP35

M flaked mineral green
 DP, DI, DU, BN, LS
 30
 R10 B
 C2C 11 NCS S 5010-B90G



75105S1515 € CP35

M flaked ocean green
 DP, DI, DU, BN
 30
 R10 B
 C2C 9 NCS S 5020-B10G



75115S1515 € CP35

M flaked moss green
 DP, DI, DU, BN
 30
 R10 B
 C2C 20 NCS S 4005-G50Y



75125S1515 € CP35

M flaked night blue
 DP, DI, DU, BN, LS
 30
 R10 B
 C2C 9 NCS S 6010-R90B



75135S1515 € CP35

M flaked aqua blue
 DP, DI, DU, BN
 30
 R10 B
 C2C 15 NCS S 5010-R90B



75155S1515 € CP35

M flaked opal blue
 DP, DI, DU, BN
 30
 R10 B
 C2C 21 NCS S 4010-R70B

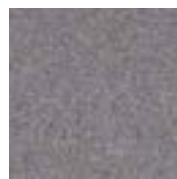

75185S1515 € CP35

M flaked lila red
 DP, DI, DU, BN
 30
 R10 B
 C2C 21 NCS S 4005-R20B



75205S1515 € CP35

M flaked galactic black
 DP, DI, DU, LS, TS, WS, BN, 75201GL,
 75201GS
 30
 R10 B
 C2C 4 NCS S 7502-B



75215S1515 € CP35

M flaked seashell beige
 DP, DI, DU, BN, LS
 30
 R10 B
 C2C 35 NCS S 3005-Y50R

Voor tegelpatronen zie generator.mosa.com.
 Pour des motifs de carreaux, visitez generator.mosa.com.
 Für Verlegemuster siehe generator.mosa.com.
 For tile patterns see generator.mosa.com.

15 Global Collection

vloertegels / carreaux de sol / Bodenfliesen / floor tiles
 Ultragres ongeglazuurd / non émaillé / unglasiert / unglazed
 vorstbestand / ingélif / frostsicher / frost proof

bijpassende wandtegels / carreaux de faïence correspondants /
 dazugehörige Wandfliesen / matching wall tiles
 Global Collection 30 15 30

no.	mm	inch	pieces/ m ²	pieces/ m ¹	pieces/ box	boxes/ pallet	pieces/ pallet	m ² / pallet	kg/ m ²	kg/ pallet
75225S - 75083S	146x146x7	5.75x5.75x0.28	44	-	33 = 0,75 m ²	92	3.036	69,0	15,3	1.082



75225S1515 € CP35

M flaked flint grey
 DP, DI, DU, BN
 30 30
 R10 B
 C2C 23 NCS S 6000-N



75235S1515 € CP35

M flaked stone grey
 DP, DI, DU, LS, BN
 30 30
 R10 B
 C2C 13 NCS S 5502-B



76015S1515 € CP35

M flaked moonstone white
 DP, DI, DU, LS, BN, 75211GL, 75211GS
 30 30
 R10 B
 C2C 47 NCS S 1500-N



76245S1515 € CP35

M flaked volcanic grey
 DP, DI, DU, BN
 30 30
 R10 B
 C2C 10 NCS S 6502-Y50R



76255S1515 € CP35

M flaked granite grey
 DP, DI, DU, BN
 30 30
 R10 B
 C2C 10 NCS S 6502-B



76265S1515 € CP35

M flaked maroon red
 DP, DI, DU, LS, BN
 30 30
 R10 B
 C2C 10 NCS S 6020-Y70R



76275S1515 € CP35

M flaked glacier grey
 DP, DI, DU, BN, LS, TS, WS
 30 30
 R10 B
 C2C 34 NCS S 2502-B



76285S1515 € CP35

M flaked pebble grey
 DP, DI, DU, BN
 30 30
 R10 B
 C2C 27 NCS S 4004-Y20R



75053S1515 € CP35

M granulated clay grey
 DP, DI, DU
 10 30
 R10 B
 C2C 20 NCS S 4005-Y50R



75063S1515 € CP35

M granulated sun yellow
 DP, DI, DU
 10 30
 R10 B
 C2C 33 NCS S 3020-Y20R



75073S1515 € CP35

M granulated dune yellow
 DP, DI, DU
 10 30
 R10 B
 C2C 34 NCS S 3010-Y30R



75083S1515 € CP35

M granulated copper green
 DP, DI, DU
 10 30
 R10 B
 C2C 13 NCS S 5010-G10Y

15 Global Collection

vloertegels / carreaux de sol / Bodenfliesen / floor tiles
 Ultragres ongeglazuurd / non émaillé / unglasiert / unglazed
 vorstbestand / ingélif / frostsicher / frost proof

bijpassende wandtegels / carreaux de faïence correspondants /
 dazugehörige Wandfliesen / matching wall tiles
 Global Collection 30 43 33

no.	mm	inch	pieces/ m ²	pieces/ m ¹	pieces/ box	boxes/ pallet	pieces/ pallet	m ² / pallet	kg/ m ²	kg/ pallet
75103S - 76243S	146x146x7	5.75x5.75x0.28	44	-	33 = 0,75 m ²	92	3.036	69,0	15,3	1.082



75103S1515 € CP35

M granulated ivy green
 DP, DI, DU
 10 50
 R10 B
 C2C 15 NCS S 5010-B10G



75113S1515 € CP35

M granulated sage green
 DP, DI, DU
 10 50
 R10 B
 C2C 24 NCS S 3010-G40Y



75123S1515 € CP35

M granulated sapphire blue
 DP, DI, DU
 10 50
 R10 B
 C2C 14 NCS S 5020-R90B

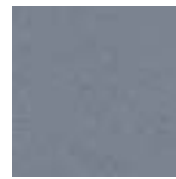

75133S1515 € CP35

M granulated sky blue
 DP, DI, DU
 10 50
 R10 B
 C2C 21 NCS S 4010-R90B



75153S1515 € CP35

M granulated lavender blue
 DP, DI, DU
 10 50
 R10 B
 C2C 22 NCS S 4005-R80B



75183S1515 € CP35

M granulated pink red
 DP, DI, DU
 10 50
 R10 B
 C2C 23 NCS S 4010-Y90R



75203S1515 € CP35

M granulated stardust black
 DP, DI, DU, 75201GL, 75201GS
 10 50
 R10 B
 C2C 6 NCS S 7500-N



75213S1515 € CP35

M granulated eggshell beige
 DP, DI, DU
 10 50
 R10 B
 C2C 38 NCS S 2005-Y40R



75223S1515 € CP35

M granulated zinc grey
 DP, DI, DU
 10 50
 R10 B
 C2C 39 NCS S 4000-N



75233S1515 € CP35

M granulated slate grey
 DP, DI, DU
 10 50
 R10 B
 C2C 16 NCS S 4502-G

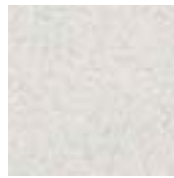

76013S1515 € CP35

M granulated crystal white
 DP, DI, DU, 75211GL, 75211GS
 10 50
 R10 B
 C2C 49 NCS S 1502-G50Y



76243S1515 € CP35

M granulated earth grey
 DP, DI, DU
 10 50
 R10 B
 C2C 11 NCS S 6005-Y80R

15 Global Collection

vloertegels / carreaux de sol / Bodenfliesen / floor tiles
 Ultragres ongeglazuurd / non émaillé / unglasiert / unglazed
 vorstbestand / ingélif / frostsicher / frost proof

bijpassende wandtegels / carreaux de faïence correspondants /
 dazugehörige Wandfliesen / matching wall tiles
 Global Collection 30 15 30

no.	mm	inch	pieces/ m ²	pieces/ m ¹	pieces/ box	boxes/ pallet	pieces/ pallet	m ² / pallet	kg/ m ²	kg/ pallet
76253S - 75130V	146x146x7	5.75x5.75x0.28	44	-	33 = 0,75 m ²	92	3.036	69,0	15,3	1.082



76253S1515 € CP35

M granulated basalt grey
 DP, DI, DU
 R10 B
 S 5502-R50B

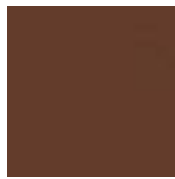

76263S1515 € CP35

M granulated cotto red
 DP, DI, DU
 R10 B
 S 5020-Y60R



76273S1515 € CP35

M granulated silver grey
 DP, DI, DU
 R10 B
 S 2000-N



76283S1515 € CP35

M granulated sand grey
 DP, DI, DU
 R10 B
 S 3005-Y50R



75050V1515 € CP35

M plain agate grey
 DP, DI, DU
 R10 A
 S 5005-Y50R



75060V1515 € CP35

M plain Naples yellow
 DP, DI, DU
 R10 A
 S 2030-Y20R



75070V1515 € CP35

M plain sand yellow
 DP, DI, DU
 R10 A
 S 2020-Y20R



75080V1515 € CP35

M plain olive green
 DP, DI, DU
 R10 A
 S 3020-G20Y



75100V1515 € CP35

M plain turquoise
 DP, DI, DU
 R10 A
 S 6020-B30G



75110V1515 € CP35

M plain mint green
 DP, DI, DU
 R10 A
 S 3010-G



75120V1515 € CP35

M plain Prussian blue
 DP, DI, DU
 R10 A
 S 6020-R90B



75130V1515 € CP35

M plain Sèvres blue
 DP, DI, DU
 R10 A
 S 2020-R90B

15 Global Collection

vloertegels / carreaux de sol / Bodenfliesen / floor tiles
 Ultragres ongeglazuurd / non émaillé / unglasiert / unglazed
 vorstbestand / ingélif / frostsicher / frost proof

bijpassende wandtegels / carreaux de faïence correspondants /
 dazugehörige Wandfliesen / matching wall tiles
 Global Collection 30 43 53

no.	mm	inch	pieces/ m ²	pieces/ m ¹	pieces/ box	boxes/ pallet	pieces/ pallet	m ² / pallet	kg/ m ²	kg/ pallet
75150V - 76280V	146x146x7	5.75x5.75x0.28	44	-	33 = 0,75 m ²	92	3.036	69,0	15,3	1.082

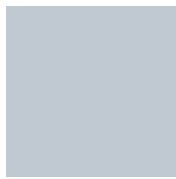

75150V1515 € CP35

M plain dove blue
 DP, DI, DU
 30
 R10 A
 C2C 35 NCS S 4005-R80B



75180V1515 € CP35

M plain light oxide red
 DP, DI, DU
 30
 R10 A
 C2C 23 NCS S 4020-Y70R



75200V1515 € CP35

M plain ivory black
 DP, DI, DU, 75201GL, 75201GS
 30
 R10 A
 C2C 7 NCS S 8000-N

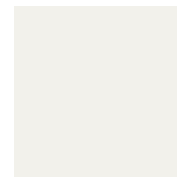

75210V1515 € CP35

M plain white unbleached
 DP, DI, DU
 30
 R10 A
 C2C 59 NCS S 1005-Y10R



75220V1515 € CP35

M plain grey
 DP, DI, DU
 30
 R10 A
 C2C 38 NCS S 3000-N



75230V1515 € CP35

M plain mouse grey
 DP, DI, DU
 30
 R10 A
 C2C 23 NCS S 5500-N

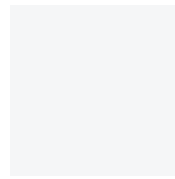

76010V1515 € CP35

M plain accent white
 DP, DI, DU, 75211GL, 75211GS
 30
 R10 A
 C2C 73 NCS S 0500-N



76240V1515 € CP35

M plain warm grey
 DP, DI, DU
 30
 R10 A
 C2C 13 NCS S 7005-Y20R



76250V1515 € CP35

M plain anthracite
 DP, DI, DU
 30
 R10 A
 C2C 15 NCS S 6500-N



76260V1515 € CP35

M plain Sienna red
 DP, DI, DU
 30
 R10 A
 C2C 12 NCS S 5030-Y70R

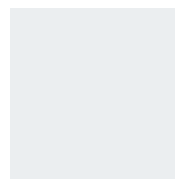

76270V1515 € CP35

M plain white grey
 DP, DI, DU
 30
 R10 A
 C2C 47 NCS S 1505-Y90R



76280V1515 € CP35

M plain light warm grey
 DP, DI, DU
 30
 R10 A
 C2C 24 NCS S 2005-Y50R

15 Scenes

vloertegels / carreaux de sol / Bodenfliesen / floor tiles
 Ultragres ongeglazuurd / non émaillé / unglasiert / unglazed
 vorstbestand / ingélif / frostsicher / frost proof

no.	mm	inch	pieces/ m ²	pieces/ m ¹	pieces/ box	boxes/ pallet	pieces/ pallet	m ² / pallet	kg/ m ²	kg/ pallet
6110V - 6142V	146x146x7,5	5.75x5.75x0.30	44	-	33 = 0,75 m ²	92	3.036	69,0	16,5	1.164



6110V1515 € BP22

M white grey grain
 6114 (DP, DI, DU, SP)
 MR
 R10 A C2C 59



6111V1515 € BP22

M white grey clay
 6114 (DP, DI, DU, SP)
 R10 A C2C 51



6112V1515 € BP22

M white grey sand
 6114 (DP, DI, DU, SP)
 R10 A C2C 44

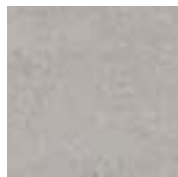

6120V1515 € BP22

M cool grey grain
 6124 (DP, DI, DU, SP)
 MR
 R10 A C2C 40



6121V1515 € BP22

M cool grey clay
 6124 (DP, DI, DU, SP)
 R10 A C2C 37



6122V1515 € BP22

M cool grey sand
 6124 (DP, DI, DU, SP)
 R10 A C2C 28



6130V1515 € BP22

M green grey grain
 6134 (DP, DI, DU, SP)
 MR
 R10 A C2C 22



6131V1515 € BP22

M green grey clay
 6134 (DP, DI, DU, SP)
 R10 A C2C 21



6132V1515 € BP22

M green grey sand
 6134 (DP, DI, DU, SP)
 R10 A C2C 16



6140V1515 € BP22

M dark anthracite grain
 6144 (DP, DI, DU, SP)
 MR
 R10 A C2C 11

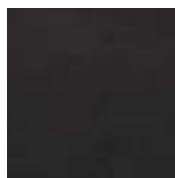

6141V1515 € BP22

M dark anthracite clay
 6144 (DP, DI, DU, SP)
 R10 A C2C 10



6142V1515 € BP22

M dark anthracite sand
 6144 (DP, DI, DU, SP)
 R10 A C2C 9

15 Scenes

vloertegels / carreaux de sol / Bodenfliesen / floor tiles
 Ultragres ongeglazuurd / non émaillé / unglasiert / unglazed
 vorstbestand / ingélif / frostsicher / frost proof

no.	mm	inch	pieces/ m ²	pieces/ m ¹	pieces/ box	boxes/ pallet	pieces/ pallet	m ² / pallet	kg/ m ²	kg/ pallet
6150V - 6172V	146x146x7,5	5.75x5.75x0.30	44	-	33 = 0,75 m ²	92	3.036	69,0	16,5	1.164



6150V1515 € BP22

M mid beige grain
 6154 (DP, DI, DU, SP)
 MR
 R10 A C2C 44



6151V1515 € BP22

M mid beige clay
 6154 (DP, DI, DU, SP)
 R10 A C2C 35

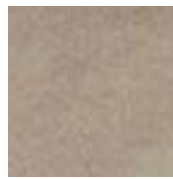

6152V1515 € BP22

M mid beige sand
 6154 (DP, DI, DU, SP)
 R10 A C2C 33



6160V1515 € BP22

M warm ochre grain
 6164 (DP, DI, DU, SP)
 MR
 R10 A C2C 31



6161V1515 € BP22

M warm ochre clay
 6164 (DP, DI, DU, SP)
 R10 A C2C 29



6162V1515 € BP22

M warm ochre sand
 6164 (DP, DI, DU, SP)
 R10 A C2C 23

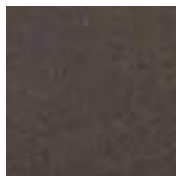

6170V1515 € BP22

M warm grey grain
 6174 (DP, DI, DU, SP)
 MR
 R10 A C2C 18



6171V1515 € BP22

M warm grey clay
 6174 (DP, DI, DU, SP)
 R10 A C2C 15

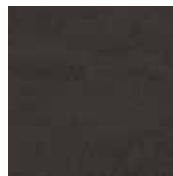

6172V1515 € BP22

M warm grey sand
 6174 (DP, DI, DU, SP)
 R10 A C2C 14

Softline

vloertegels / carreaux de sol / Bodenfliesen / floor tiles
 Ultragres ongeglazuurd / non émaillé / unglasiert / unglazed
 vorstbestand / ingélif / frostsicher / frost proof

no.	mm	inch	pieces/ m ²	pieces/ m ¹	pieces/ box	boxes/ pallet	pieces/ pallet	m ² / pallet	kg/ m ²	kg/ pallet
74020V - 74090V	146x146x7	5.75x5.75x0.28	44	-	33 = 0,75 m ²	92	3.036	69,0	15,3	1.082



74020V1515   **FH1**

 grijs / gris /
 grau / grey

 DP, DI, DU, VS, HS

 LS1515, LS3030

 R10  A  C2C  38

74030V1515   **FH1**

 muisgrijs / gris de souris /
 mausgrau / mouse grey

 DP, DI, DU, VS, HS

 LS1515, LS3030

 R10  A  C2C  24

74090V1515   **FH1**

 ivoorzwart / noir d'ivoire /
 elfenbeinschwarz / ivory black

 DP, DI, DU, VS, HS

 LS1515, LS3030

 R10  A  C2C  9



3030 Core Collection Terra

vloertegels / carreaux de sol / Bodenfliesen / floor tiles
 Ultragres ongeglazuurd / non émaillé / unglasiert / unglazed
 vorstbestand / ingélf / frostsicher / frost proof

no.	mm	inch	pieces/ m ²	pieces/ m ¹	pieces/ box	boxes/ pallet	pieces/ pallet	m ² / pallet	kg/ m ²	kg/ pallet
203V - 229V	296x296x10	11.65x11.65x0.39	11	-	10 = 0,909 m ²	48	480	43,6	23,3	1.043



203V3030 BP22

M cool black
 BP, 103VM, 103HM, TVG, HV

 RL
 R10 8



204V3030 BP22

M mid warm grey
 304SP, BP, 104VM, 104HM, TVG, HV

 RL
 R10 22



206V3030 BP22

M mid grey
 306SP, BP, TVG, HV

 RL
 R10 34



211V3030 BP22

M avalon beige
 BP, TVG, HV

 RL
 R10 51



216V3030 BP22

M anthracite
 316SP, BP, 116VM, 116HM, TVG, HV

 RL
 R10 12



225V3030 BP22

M light cool grey
 BP, 125VM, 125HM

 RL
 R10 40



226V3030 BP22

M mid cool grey
 BP, 126VM, 126HM, TVG, HV

 RL
 R10 23



227V3030 BP22

M dark cool grey
 BP, TVG, HV

 RL
 R10 14



229V3030 BP22

M dark warm grey
 BP, TVG, HV



 RL
 R10 14













Core Collection Terra

vloertegels / carreaux de sol / Bodenfliesen / floor tiles
 Ultragres ongeglazuurd / non émaillé / unglasiert / unglazed
 vorstbestand / ingélif / frostsicher / frost proof



no.	mm	inch	pieces/ m ²	pieces/ m ¹	pieces/ box	boxes/ pallet	pieces/ pallet	m ² / pallet	kg/ m ²	kg/ pallet
264V - 266V	296x296x10	11.65x11.65x0.39	11	-	10 = 0,909 m ²	48	480	43,6	23,3	1.043















264V3030   BP22

 grey brown
 BP, 164VM, 164HM
  
   
   15



266V3030   BP22

 light beige
 BP, 166VM, 166HM
  
     RL
   49

3030 Global Collection

vloertegels / carreaux de sol / Bodenfliesen / floor tiles
 Ultragres ongeglazuurd / non émaillé / unglasiert / unglazed
 vorstbestand / ingélif / frostsicher / frost proof

bijpassende wandtegels / carreaux de faïence correspondants /
 dazugehörige Wandfliesen / matching wall tiles
 Global Collection 30 13 30

no.	mm	inch	pieces/ m ²	pieces/ m ¹	pieces/ box	boxes/ pallet	pieces/ pallet	m ² / pallet	kg/ m ²	kg/ pallet
750555 - 751555	296x296x8	11.65x11.65x0.31	11	-	13 = 1,182 m ²	48	624	56,7	18,3	1.063



7505553030 € CP35
 M flaked pumice grey
 DP, DI, DU, BN, LS
 R10 B C2C 16 NCS S 65005-Y



7506553030 € CP35
 M flaked ochre yellow
 DP, DI, DU, BN
 R10 B C2C 24 NCS S 4020-Y30R



7507553030 € CP35
 M flaked bronze yellow
 DP, DI, DU, BN, LS
 R10 B C2C 29 NCS S 3020-Y40R



7508553030 € CP35
 M flaked mineral green
 DP, DI, DU, BN, LS
 R10 B C2C 11 NCS S 5010-B90G



7510553030 € CP35
 M flaked ocean green
 DP, DI, DU, BN
 R10 B C2C 9 NCS S 5020-B10G



7511553030 € CP35
 M flaked moss green
 DP, DI, DU, BN
 R10 B C2C 20 NCS S 4005-G50Y



7512553030 € CP35
 M flaked night blue
 DP, DI, DU, BN, LS
 R10 B C2C 9 NCS S 6010-R90B



7513553030 € CP35
 M flaked aqua blue
 DP, DI, DU, BN
 R10 B C2C 15 NCS S 5010-R90B



7515553030 € CP35
 M flaked opal blue
 DP, DI, DU, BN
 R10 B C2C 21 NCS S 4010-R70B

3030 Global Collection

vloertegels / carreaux de sol / Bodenfliesen / floor tiles
 Ultragres ongeglazuurd / non émaillé / unglasiert / unglazed
 vorstbestand / ingélif / frostsicher / frost proof

bijpassende wandtegels / carreaux de faïence correspondants /
 dazugehörige Wandfliesen / matching wall tiles
 Global Collection 30 30 30

no.	mm	inch	pieces/ m ²	pieces/ m ¹	pieces/ box	boxes/ pallet	pieces/ pallet	m ² / pallet	kg/ m ²	kg/ pallet
751855 - 762655	296x296x8	11.65x11.65x0.31	11	-	13 = 1,182 m ²	48	624	56,7	18,3	1.063



7518553030 € CP35
 M flaked lila red
 DP, DI, DU, BN
 R10 B C2C 21 NCS S 4005-R20B



7520553030 € CP35
 M flaked galactic black
 DP, DI, DU, LS, TS, WS, BN, 75201GL, 75201GS
 R10 B C2C 4 NCS S 7502-B

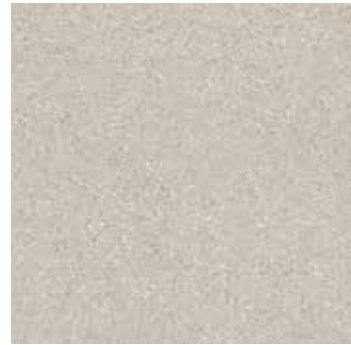

7521553030 € CP35
 M flaked seashell beige
 DP, DI, DU, BN, LS
 R10 B C2C 35 NCS S 3005-Y50R



7522553030 € CP35
 M flaked flint grey
 DP, DI, DU, BN
 R10 B C2C 23 NCS S 6000-N



7523553030 € CP35
 M flaked stone grey
 DP, DI, DU, LS, BN
 R10 B C2C 13 NCS S 5502-B



7601553030 € CP35
 M flaked moonstone white
 DP, DI, DU, LS, BN, 75211GL, 75211GS
 R10 B C2C 47 NCS S 1500-N



7624553030 € CP35
 M flaked volcanic grey
 DP, DI, DU, BN
 R10 B C2C 10 NCS S 6502-Y50R



7625553030 € CP35
 M flaked granite grey
 DP, DI, DU, BN
 R10 B C2C 10 NCS S 6502-B



7626553030 € CP35
 M flaked maroon red
 DP, DI, DU, LS, BN
 R10 B C2C 10 NCS S 6020-Y70R

3030 Global Collection

vloertegels / carreaux de sol / Bodenfliesen / floor tiles
 Ultragres ongeglazuurd / non émaillé / unglasiert / unglazed
 vorstbestand / ingélif / frostsicher / frost proof

bijpassende wandtegels / carreaux de faïence correspondants /
 dazugehörige Wandfliesen / matching wall tiles
 Global Collection 30 13 30

no.	mm	inch	pieces/ m ²	pieces/ m ¹	pieces/ box	boxes/ pallet	pieces/ pallet	m ² / pallet	kg/ m ²	kg/ pallet
76275S - 75123S	296x296x8	11.65x11.65x0.31	11	-	13 = 1,182 m ²	48	624	56,7	18,3	1.063



76275S3030 € CP35
 M flaked glacier grey
 DP, DI, DU, BN, LS, TS, WS
 R10 B C2C 34 S 2502-B



76285S3030 € CP35
 M flaked pebble grey
 DP, DI, DU, BN
 R10 B C2C 27 S 4004-Y20R

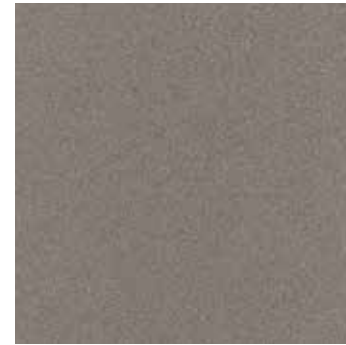

75053S3030 € CP35
 M granulated clay grey
 DP, DI, DU
 R10 B C2C 20 S 4005-Y50R



75063S3030 € CP35
 M granulated sun yellow
 DP, DI, DU
 R10 B C2C 33 S 3020-Y20R



75073S3030 € CP35
 M granulated dune yellow
 DP, DI, DU
 R10 B C2C 34 S 3010-Y30R



75083S3030 € CP35
 M granulated copper green
 DP, DI, DU
 R10 B C2C 13 S 5010-G10Y



75103S3030 € CP35
 M granulated ivy green
 DP, DI, DU
 R10 B C2C 15 S 5010-B10G



75113S3030 € CP35
 M granulated sage green
 DP, DI, DU
 R10 B C2C 24 S 3010-G40Y



75123S3030 € CP35
 M granulated sapphire blue
 DP, DI, DU
 R10 B C2C 14 S 5020-R90B

3030 Global Collection

vloertegels / carreaux de sol / Bodenfliesen / floor tiles
 Ultragres ongeglazuurd / non émaillé / unglasiert / unglazed
 vorstbestand / ingélif / frostsicher / frost proof

bijpassende wandtegels / carreaux de faïence correspondants /
 dazugehörige Wandfliesen / matching wall tiles
 Global Collection 30 30 30

no.	mm	inch	pieces/ m ²	pieces/ m ¹	pieces/ box	boxes/ pallet	pieces/ pallet	m ² / pallet	kg/ m ²	kg/ pallet
751335 - 762435	296x296x8	11.65x11.65x0.31	11	-	13 = 1,182 m ²	48	624	56,7	18,3	1.063



7513353030 € CP35
 M granulated sky blue
 DP, DI, DU
 R10 B C2C 21 NCS S 4010-R90B



7515353030 € CP35
 M granulated lavender blue
 DP, DI, DU
 R10 B C2C 22 NCS S 4005-R80B



7518353030 € CP35
 M granulated pink red
 DP, DI, DU
 R10 B C2C 23 NCS S 4010-Y90R



7520353030 € CP35
 M granulated stardust black
 DP, DI, DU, 75201GL, 75201GS
 R10 B C2C 6 NCS S 7500-N



7521353030 € CP35
 M granulated eggshell beige
 DP, DI, DU
 R10 B C2C 38 NCS S 2005-Y40R



7522353030 € CP35
 M granulated zinc grey
 DP, DI, DU
 R10 B C2C 39 NCS S 4000-N



7523353030 € CP35
 M granulated slate grey
 DP, DI, DU
 R10 B C2C 16 NCS S 4502-G



7601353030 € CP35
 M granulated crystal white
 DP, DI, DU, 75211GL, 75211GS
 R10 B C2C 49 NCS S 1502-G50Y



7624353030 € CP35
 M granulated earth grey
 DP, DI, DU
 R10 B C2C 11 NCS S 6005-Y80R

3030 Global Collection

vloertegels / carreaux de sol / Bodenfliesen / floor tiles
 Ultragres ongeglazuurd / non émaillé / unglasiert / unglazed
 vorstbestand / ingélif / frostsicher / frost proof

bijpassende wandtegels / carreaux de faïence correspondants /
 dazugehörige Wandfliesen / matching wall tiles
 Global Collection 30 13 30

no.	mm	inch	pieces/ m ²	pieces/ m ¹	pieces/ box	boxes/ pallet	pieces/ pallet	m ² / pallet	kg/ m ²	kg/ pallet
762535 - 75100V	296x296x8	11.65x11.65x0.31	11	-	13 = 1,182 m ²	48	624	56,7	18,3	1.063



7625353030 € CP35
 M granulated basalt grey
 DP, DI, DU
 R10 B C2C 11 NCS S 5502-R50B



7626353030 € CP35
 M granulated cotto red
 DP, DI, DU
 R10 B C2C 16 NCS S 5020-Y60R



7627353030 € CP35
 M granulated silver grey
 DP, DI, DU
 R10 B C2C 39 NCS S 2000-N



7628353030 € CP35
 M granulated sand grey
 DP, DI, DU
 R10 B C2C 31 NCS S 3005-Y50R

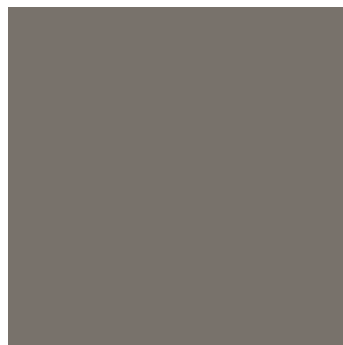

75050V3030 € CP35
 M plain agate grey
 DP, DI, DU
 R10 A C2C 20 NCS S 5005-Y50R



75060V3030 € CP35
 M plain Naples yellow
 DP, DI, DU
 R10 A C2C 39 NCS S 2030-Y20R



75070V3030 € CP35
 M plain sand yellow
 DP, DI, DU
 R10 A C2C 51 NCS S 2020-Y20R

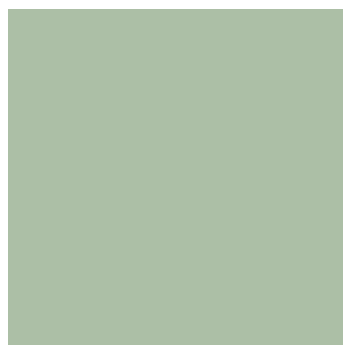

75080V3030 € CP35
 M plain olive green
 DP, DI, DU
 R10 A C2C 29 NCS S 3020-G20Y



75100V3030 € CP35
 M plain turquoise
 DP, DI, DU
 R10 A C2C 16 NCS S 6020-B30G

3030 Global Collection

vloertegels / carreaux de sol / Bodenfliesen / floor tiles
 Ultragres ongeglazuurd / non émaillé / unglasiert / unglazed
 vorstbestand / ingélif / frostsicher / frost proof

bijpassende wandtegels / carreaux de faïence correspondants /
 dazugehörige Wandfliesen / matching wall tiles
 Global Collection 30 30 30

no.	mm	inch	pieces/ m ²	pieces/ m ¹	pieces/ box	boxes/ pallet	pieces/ pallet	m ² / pallet	kg/ m ²	kg/ pallet
75110V - 75230V	296x296x8	11.65x11.65x0.31	11	-	13 = 1,182 m ²	48	624	56,7	18,3	1.063

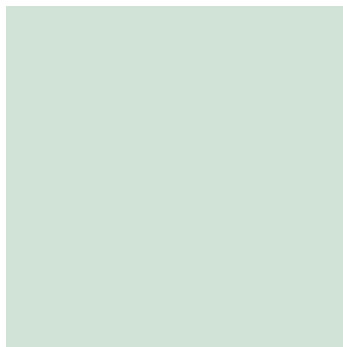

75110V3030 € CP35
M plain mint green
 DP, DI, DU
 R10 A C2C 40 NCS S 3010-G



75120V3030 € CP35
M plain Prussian blue
 DP, DI, DU
 R10 A C2C 11 NCS S 6020-R90B



75130V3030 € CP35
M plain Sèvres blue
 DP, DI, DU
 R10 A C2C 36 NCS S 2020-R90B

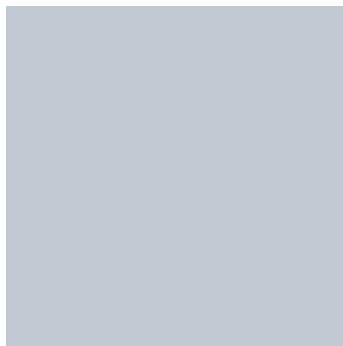

75150V3030 € CP35
M plain dove blue
 DP, DI, DU
 R10 A C2C 35 NCS S 4005-R80B



75180V3030 € CP35
M plain light oxide red
 DP, DI, DU
 R10 A C2C 23 NCS S 4020-Y70R



75200V3030 € CP35
M plain ivory black
 DP, DI, DU, 75201GL, 75201GS
 R10 A C2C 7 NCS S 8000-N

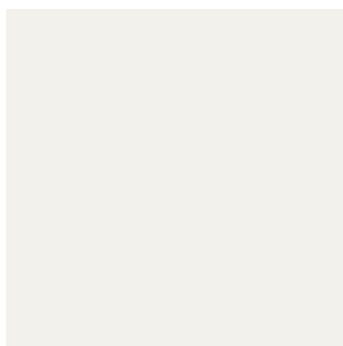

75210V3030 € CP35
M plain white unbleached
 DP, DI, DU
 R10 A C2C 59 NCS S 1005-Y10R

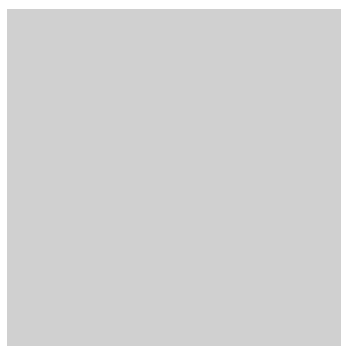

75220V3030 € CP35
M plain grey
 DP, DI, DU
 R10 A C2C 38 NCS S 3000-N



75230V3030 € CP35
M plain mouse grey
 DP, DI, DU
 R10 A C2C 23 NCS S 5500-N

3030 Global Collection

vloertegels / carreaux de sol / Bodenfliesen / floor tiles
 Ultragres ongeglazuurd / non émaillé / unglasiert / unglazed
 vorstbestand / ingélif / frostsicher / frost proof

bijpassende wandtegels / carreaux de faïence correspondants /
 dazugehörige Wandfliesen / matching wall tiles
 Global Collection 30 13 30

no.	mm	inch	pieces/ m ²	pieces/ m ¹	pieces/ box	boxes/ pallet	pieces/ pallet	m ² / pallet	kg/ m ²	kg/ pallet
76010V - 76280V	296x296x8	11.65x11.65x0.31	11	-	13 = 1,182 m ²	48	624	56,7	18,3	1.063

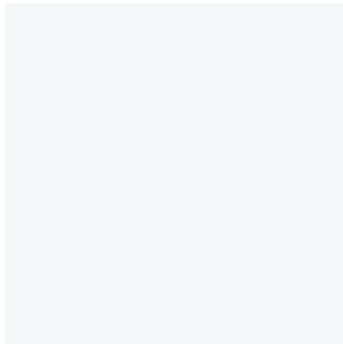

76010V3030 € CP35
 M plain accent white
 DP, DI, DU, 75211GL, 75211GS
 R10 A C2C 73 NCS S 0500-N



76240V3030 € CP35
 M plain warm grey
 DP, DI, DU
 R10 A C2C 13 NCS S 7005-Y20R



76250V3030 € CP35
 M plain anthracite
 DP, DI, DU
 R10 A C2C 15 NCS S 6500-N



76260V3030 € CP35
 M plain Sienna red
 DP, DI, DU
 R10 A C2C 12 NCS S 5030-Y70R

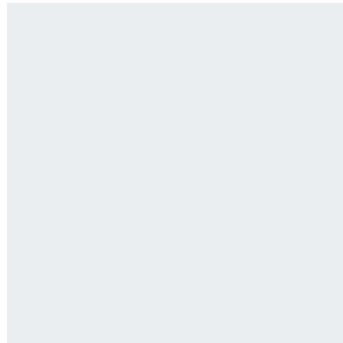

76270V3030 € CP35
 M plain white grey
 DP, DI, DU
 R10 A C2C 47 NCS S 1505-Y90R

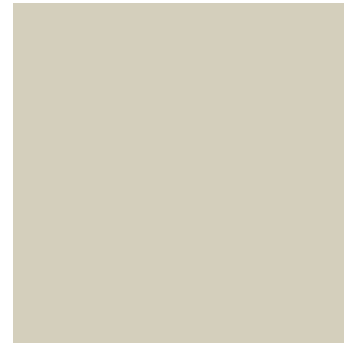

76280V3030 € CP35
 M plain light warm grey
 DP, DI, DU
 R10 A C2C 24 NCS S 2005-Y50R

Voor tegelpatronen zie generator.mosa.com.
 Pour des motifs de carreaux, visitez generator.mosa.com.
 Für Verlegemuster siehe generator.mosa.com.
 For tile patterns see generator.mosa.com.









Core Collection Solids

vloertegels / carreaux de sol / Bodenfliesen / floor tiles
 Ultragres ongeglazuurd / non émaillé / unglasiert / unglazed
 vorstbestand / ingélif / frostsicher / frost proof

no.	mm	inch	pieces/ m ²	pieces/ m ¹	pieces/ box	boxes/ pallet	pieces/ pallet	m ² / pallet	kg/ m ²	kg/ pallet
5102V - 5112V	297x597x12	11.69x23.50x0.47	5,56	-	4 = 0,719 m ²	48	192	34,5	26,5	941











5102V3060  BP03

 vivid white
 5002SP, BP, TVG, HV



    58











5104V3060  BP03

 clay grey
 BP, TVG, HV

    28











5106V3060  BP03

 agate grey
 5006SP, BP, TVG, HV

    15











5108V3060  BP03

 stone grey
 5008SP, BP, TVG, HV



    33











5110V3060  BP03

 basalt grey
 5010SP, BP, TVG, HV



    16



5112V3060  BP03

 graphite black
 BP, TVG, HV



    10

Core Collection Solids

vloertegels / carreaux de sol / Bodenfliesen / floor tiles
 Ultragres ongeglazuurd / non émaillé / unglasiert / unglazed
 vorstbestand / ingélif / frostsicher / frost proof

no.	mm	inch	pieces/ m ²	pieces/ m ¹	pieces/ box	boxes/ pallet	pieces/ pallet	m ² / pallet	kg/ m ²	kg/ pallet
5118V - 5126V	297x597x12	11.69x23.50x0.47	5,56	-	4 = 0,719 m ²	48	192	34,5	26,5	941





5118V3060  BP03

 rust red

 R10 C2C 10



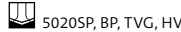



5120V3060  BP03

 jade grey

 R10 C2C 25



5126V3060  BP03

 natural beige

 R10 C2C 52

3060 Core Collection Terra

vloertegels / carreaux de sol / Bodenfliesen / floor tiles
 Ultragres ongeglazuurd / non émaillé / unglasiert / unglazed
 vorstbestand / ingélif / frostsicher / frost proof

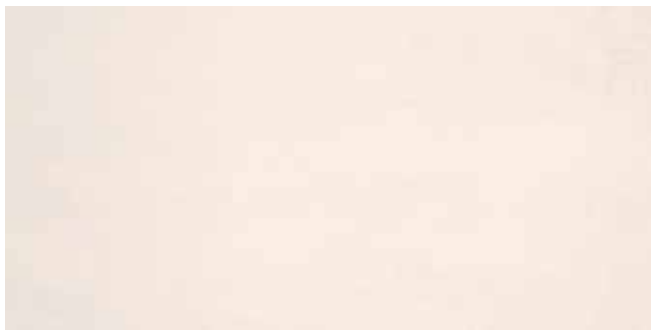
no.	mm	inch	pieces/ m ²	pieces/ m ¹	pieces/ box	boxes/ pallet	pieces/ pallet	m ² / pallet	kg/ m ²	kg/ pallet
200V - 214V	297x597x12	11.69x23.50x0.47	5,56	-	4 = 0,719 m ²	48	192	34,5	26,5	941



200V3060 € BP16

M cool porcelain white
 BP, TVG, HV
 30 60 120 90
 60 10 60 20 RL
 R10 C2C 68



203V3060 € BP16

M cool black
 BP, 103VM, 103HM, TVG, HV
 15 30 60 120 90
 60 10 60 20 RL
 R10 C2C 8



204V3060 € BP16

M mid warm grey
 304SP, BP, 104VM, 104HM, TVG, HV
 15 30 60 120 90
 60 10 60 20 RL
 R10 C2C 22



206V3060 € BP16

M mid grey
 306SP, BP, TVG, HV
 15 30 60 120 90
 60 10 60 20 RL
 R10 C2C 34



211V3060 € BP16

M avalon beige
 BP, TVG, HV
 30 60 120
 60 10 60 20 RL
 R10 C2C 51



214V3060 € BP16

M grey
 BP
 60
 R10 C2C 21

30/60 Core Collection Terra

vloertegels / carreaux de sol / Bodenfliesen / floor tiles
 Ultragres oneglazurd / non émaillé / unglasiert / unglazed
 vorstbestand / ingélif / frostsicher / frost proof

no.	mm	inch	pieces/ m ²	pieces/ m ¹	pieces/ box	boxes/ pallet	pieces/ pallet	m ² / pallet	kg/ m ²	kg/ pallet
215V - 227V	297x597x12	11.69x23.50x0.47	5,56	-	4 = 0,719 m ²	48	192	34,5	26,5	941



215V3060 € BP16

M grey green
 315SP, BP
 60
 R10 C2C 18



216V3060 € BP16

M anthracite
 316SP, BP, 116VM, 116HM, TVG, HV
 15 30 60 120 90
 60 60 60 60 RL
 R10 C2C 12



222V3060 € BP16

M mid moss-grey
 BP
 60
 60 60 60 60
 R10 C2C 25



225V3060 € BP16

M light cool grey
 BP, 125VM, 125HM
 15 30 60 120 90
 60 60 60 60
 R10 C2C 40



226V3060 € BP16

M mid cool grey
 BP, 126VM, 126HM, TVG, HV
 15 30 60 120 90
 60 60 60 60
 R10 C2C 23



227V3060 € BP16

M dark cool grey
 BP, TVG, HV
 30 60 120
 60 60 60 60
 R10 C2C 14

30/60 Core Collection Terra

vloertegels / carreaux de sol / Bodenfliesen / floor tiles
 Ultragres ongeglazuurd / non émaillé / unglasiert / unglazed
 vorstbestand / ingélif / frostsicher / frost proof

no.	mm	inch	pieces/ m ²	pieces/ m ¹	pieces/ box	boxes/ pallet	pieces/ pallet	m ² / pallet	kg/ m ²	kg/ pallet
229V - 264V	297x597x12	11.69x23.50x0.47	5,56	-	4 = 0,719 m ²	48	192	34,5	26,5	941



229V3060 € BP16

M dark warm grey
 BP, TVG, HV



238V3060 € BP16

M cool grey
 BP



239V3060 € BP16

M blue
 BP



262V3060 € BP16

M light grey beige
 362SP, BP, TVG, HV



263V3060 € BP16

M grey beige
 BP



264V3060 € BP16

M grey brown
 BP, 164VM, 164HM





Core Collection Terra

vloertegels / carreaux de sol / Bodenfliesen / floor tiles
 Ultragres ongeglazuurd / non émaillé / unglasiert / unglazed
 vorstbestand / ingélif / frostsicher / frost proof

no.	mm	inch	pieces/ m ²	pieces/ m ¹	pieces/ box	boxes/ pallet	pieces/ pallet	m ² / pallet	kg/ m ²	kg/ pallet
265V - 270V	297x597x12	11.69x23.50x0.47	5,56	-	4 = 0,719 m ²	48	192	34,5	26,5	941







265V3060 

 dark grey brown
 BP, TVG

 R10 C2C 9







266V3060 

 light beige
 BP, 166VM, 166HM

 R10 C2C 49



270V3060 

 light red beige
 BP

 R10 C2C 40

Mosa Stage

vloertegels / carreaux de sol / Bodenfliesen / floor tiles
 Ultragres ongeglazuurd / non émaillé / unglasiert / unglazed
 vorstbestand / ingélif / frostsicher / frost proof

no.	mm	inch	pieces/ m ²	pieces/ m ¹	pieces/ box	boxes/ pallet	pieces/ pallet	m ² / pallet	kg/ m ²	kg/ pallet
3502CR - 3512CR	297x597x12	11.69x23.50x0.47	5,56	-	4 = 0,719 m ²	48	192	34,5	26,5	941



3502CR3060  BP15

 cool white









3504CR3060  BP15

 light cool grey









3506CR3060  BP15

 dark cool grey

   









3508CR3060  BP15

 light warm grey

   









3510CR3060  BP15

 mid warm grey

   



3512CR3060  BP15

 dark plum brown

   

Mosa Stage

vloertegels / carreaux de sol / Bodenfliesen / floor tiles
 Ultragres ongeglazuurd / non émaillé / unglasiert / unglazed
 vorstbestand / ingélif / frostsicher / frost proof

no.	mm	inch	pieces/ m ²	pieces/ m ¹	pieces/ box	boxes/ pallet	pieces/ pallet	m ² / pallet	kg/ m ²	kg/ pallet
3514CR - 3518CR	297x597x12	11.69x23.50x0.47	5,56	-	4 = 0,719 m ²	48	192	34,5	26,5	941



3514CR3060  BP15

 sienna beige

 BP, TCG



     35



3516CR3060  BP15

 paynes grey

 BP, TCG



     14



3518CR3060  BP15

 ivory black

 BP, TCG



     8





Terra Tones

vloertegels / carreaux de sol / Bodenfliesen / floor tiles
 Ultragres ongeglazuurd / non émaillé / unglasiert / unglazed
 vorstbestand / ingélif / frostsicher / frost proof

no.	mm	inch	pieces/ m ²	pieces/ m ¹	pieces/ box	boxes/ pallet	pieces/ pallet	m ² / pallet	kg/ m ²	kg/ pallet
200XV - 203ZV	297x597x12	11.69x23.50x0.47	5,56	-	4 = 0,719 m ²	48	192	34,5	26,5	941





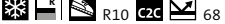

200XV3060  AP01
 200YV3060
 200ZV3060

 cool porcelain white

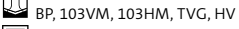



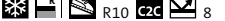

203XV3060  AP01
 203YV3060
 203ZV3060

 cool black





Terra Tones

vloertegels / carreaux de sol / Bodenfliesen / floor tiles
 Ultragres ongeglazuurd / non émaillé / unglasiert / unglazed
 vorstbestand / ingélif / frostsicher / frost proof

no.	mm	inch	pieces/ m ²	pieces/ m ¹	pieces/ box	boxes/ pallet	pieces/ pallet	m ² / pallet	kg/ m ²	kg/ pallet
206XV - 215ZV	297x597x12	11.69x23.50x0.47	5,56	-	4 = 0,719 m ²	48	192	34,5	26,5	941



206XV3060  AP01

206YV3060

206ZV3060



mid grey



306SP, BP, TVG, HV



R10 C2C 34



215XV3060  AP01

215YV3060

215ZV3060



grey green



315SP, BP



R10 C2C 18







Terra Tones

vloertegels / carreaux de sol / Bodenfliesen / floor tiles
 Ultragres ongeglazuurd / non émaillé / unglasiert / unglazed
 vorstbestand / ingélif / frostsicher / frost proof

no.	mm	inch	pieces/ m ²	pieces/ m ¹	pieces/ box	boxes/ pallet	pieces/ pallet	m ² / pallet	kg/ m ²	kg/ pallet
216XV - 266ZV	297x597x12	11.69x23.50x0.47	5,56	-	4 = 0,719 m ²	48	192	34,5	26,5	941









216XV3060  AP01
 216YV3060
 216ZV3060

 anthracite
 316SP, BP, 116VM, 116HM, TVG, HV

 R10   12



266XV3060  AP01
 266YV3060
 266ZV3060

 light beige
 BP, 166VM, 166HM

 R10   49

Voor uitgebreide verwerkingsadviezen zie www.mosa.com.
 On peut trouver toutes les directives de pose sur www.mosa.com.
 Für komplette Hinweise zur Verarbeitung siehe www.mosa.com.
 The complete guidelines for installation can be found on www.mosa.com.



60 Core Collection Quartz

vloertegels / carreaux de sol / Bodenfliesen / floor tiles
 Ultragres ongeglazuurd / non émaillé / unglasiert / unglazed
 vorstbestand / ingélif / frostsicher / frost proof

no.	mm	inch	pieces/ m ²	pieces/ m ¹	pieces/ box	boxes/ pallet	pieces/ pallet	m ² / pallet	kg/ m ²	kg/ pallet
4101V - 4104V	597x597x12	23.50x23.50x0.47	2,8	-	3 = 1,071 m ²	30	90	32,1	27,8	918



4101V6060 € AP10

M chalk white
 BP
 RQ
 R R10 C2C 64



4102V6060 € AP10

M slate grey
 BP
 RQ
 R R10 C2C 39

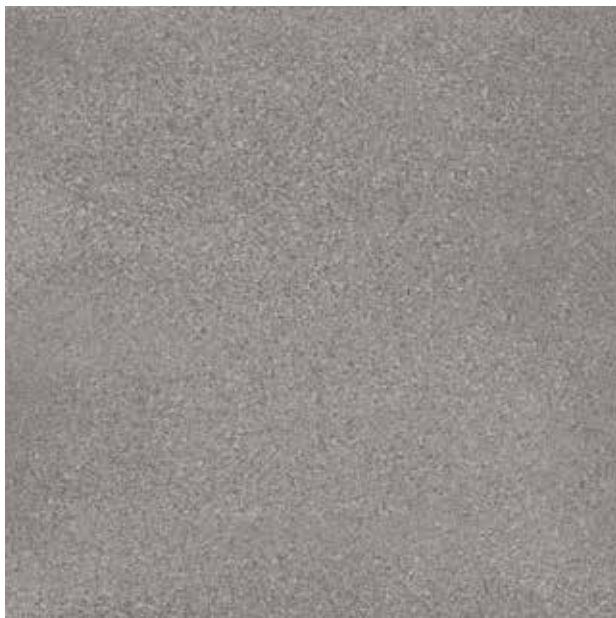

4103V6060 € AP10

M basalt grey
 BP
 RQ
 R R10 C2C 20

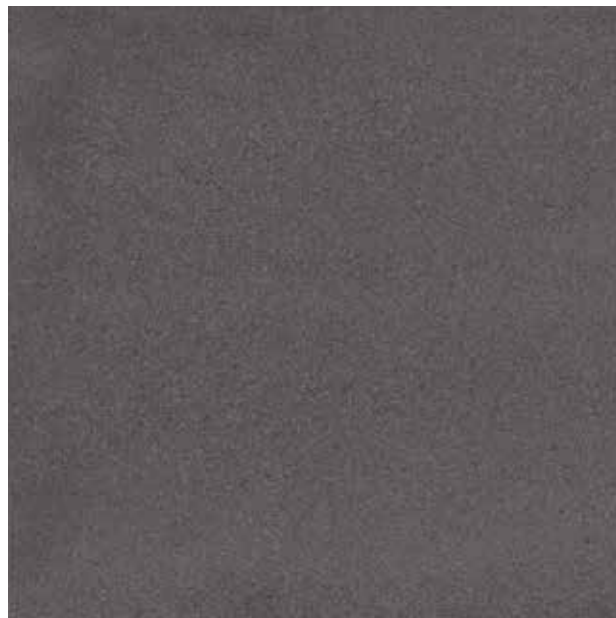

4104V6060 € AP10

M anthracite black
 BP
 RQ
 R R10 C2C 9







6060 Core Collection Quartz

vloertegels / carreaux de sol / Bodenfliesen / floor tiles
 Ultragres oneglazuurd / non émaillé / unglasiert / unglazed
 vorstbestand / ingélif / frostsicher / frost proof

no.	mm	inch	pieces/ m ²	pieces/ m ¹	pieces/ box	boxes/ pallet	pieces/ pallet	m ² / pallet	kg/ m ²	kg/ pallet
4105V - 4107V	597x597x12	23.50x23.50x0.47	2,8	-	3 = 1,071 m ²	30	90	32,1	27,8	918







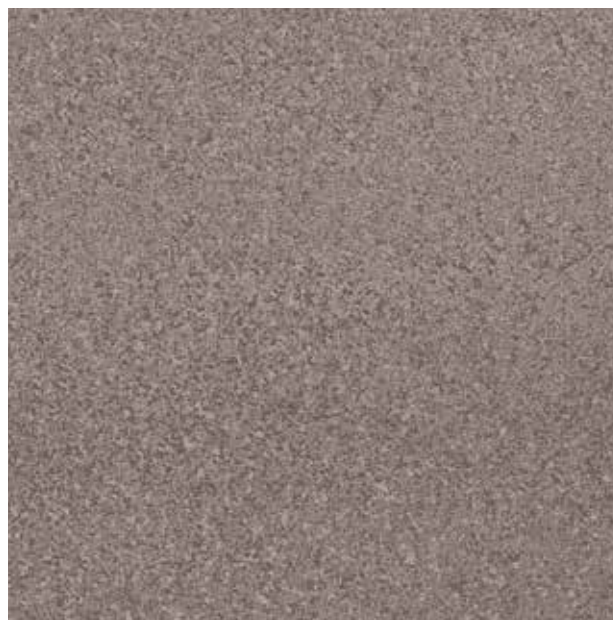

4105V6060  AP10

 sand beige
 BP
 RQ
 R  C2C  53



4107V6060  AP10

 agate grey
 BP
 RQ
 R  C2C  19

60 Core Collection Solids

vloertegels / carreaux de sol / Bodenfliesen / floor tiles
 Ultragres ongeglazuurd / non émaillé / unglasiert / unglazed
 vorstbestand / ingélif / frostsicher / frost proof

no.	mm	inch	pieces/ m ²	pieces/ m ¹	pieces/ box	boxes/ pallet	pieces/ pallet	m ² / pallet	kg/ m ²	kg/ pallet
5102V - 5108V	597x597x12	23.50x23.50x0.47	2,8	-	3 = 1,071 m ²	30	90	32,1	27,8	918



5102V6060 € BP03

M vivid white
 5002SP, BP, TVG, HV
 60 90
 10 20 40
 60 60 60
 MR
 R10 C2C 58

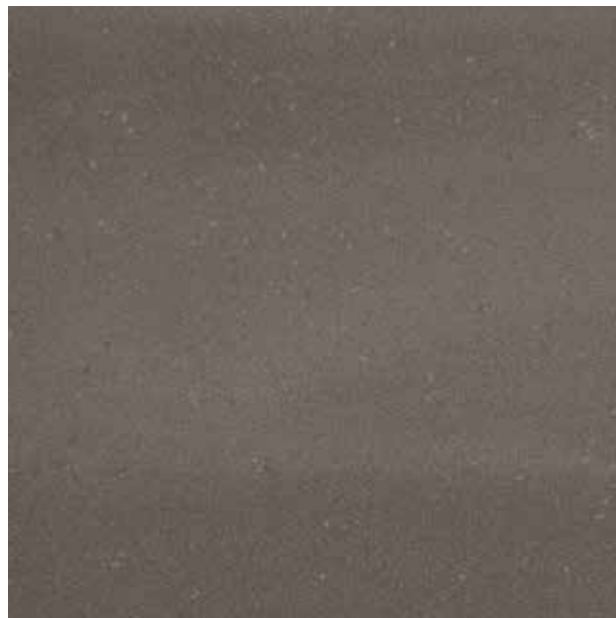

5104V6060 € BP03

M clay grey
 BP, TVG, HV
 60 90
 R10 C2C 28



5106V6060 € BP03

M agate grey
 5006SP, BP, TVG, HV
 60 90
 MR
 R10 C2C 15



5108V6060 € BP03

M stone grey
 5008SP, BP, TVG, HV
 60 90
 60 20 40 MR
 60 60 60
 R10 C2C 33

60 60 Core Collection Solids

vloertegels / carreaux de sol / Bodenfliesen / floor tiles
 Ultragres ongeglazuurd / non émaillé / unglasiert / unglazed
 vorstbestand / ingélif / frostsicher / frost proof

no.	mm	inch	pieces/ m ²	pieces/ m ¹	pieces/ box	boxes/ pallet	pieces/ pallet	m ² / pallet	kg/ m ²	kg/ pallet
5110V - 5120V	597x597x12	23.50x23.50x0.47	2,8	-	3 = 1,071 m ²	30	90	32,1	27,8	918



5110V6060 € BP03

M basalt grey
 5010SP, BP, TVG, HV
 MR
 R10 C2C 16

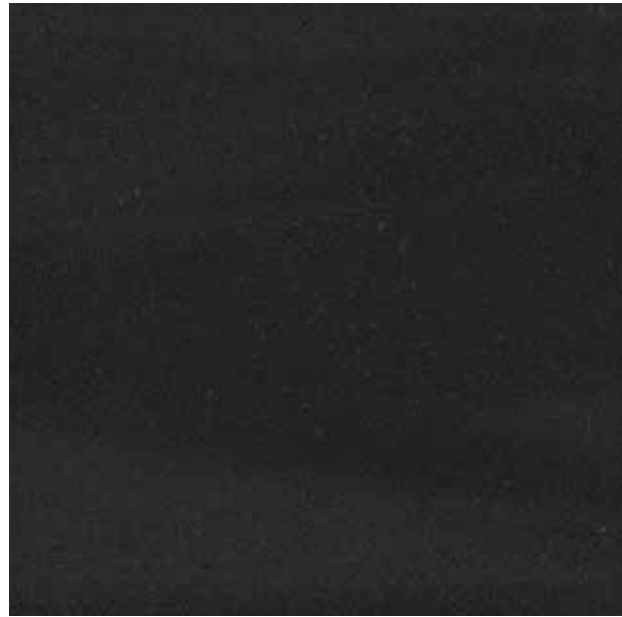

5112V6060 € BP03

M graphite black
 BP, TVG, HV
 MR
 R10 C2C 10



5118V6060 € BP03

M rust red
 BP, TVG, HV
 MR
 R10 C2C 10



5120V6060 € BP03

M jade grey
 5020SP, BP, TVG, HV
 MR
 R10 C2C 25

Core Collection Solids

vloertegels / carreaux de sol / Bodenfliesen / floor tiles
 Ultragres ongeglazuurd / non émaillé / unglasiert / unglazed
 vorstbestand / ingélif / frostsicher / frost proof

no.	mm	inch	pieces/ m ²	pieces/ m ¹	pieces/ box	boxes/ pallet	pieces/ pallet	m ² / pallet	kg/ m ²	kg/ pallet
5126V	597x597x12	23.50x23.50x0.47	2,8	-	3 = 1,071 m ²	30	90	32,1	27,8	918



5126V6060  BP03

 natural beige

 BP, TVG, HV



 R10 C2C 52

60 Core Collection Terra

vloertegels / carreaux de sol / Bodenfliesen / floor tiles
 Ultragres ongeglazuurd / non émaillé / unglasiert / unglazed
 vorstbestand / ingélif / frostsicher / frost proof

no.	mm	inch	pieces/ m ²	pieces/ m ¹	pieces/ box	boxes/ pallet	pieces/ pallet	m ² / pallet	kg/ m ²	kg/ pallet
200V - 206V	597x597x12	23.50x23.50x0.47	2,8	-	3 = 1,071 m ²	30	90	32,1	27,8	918

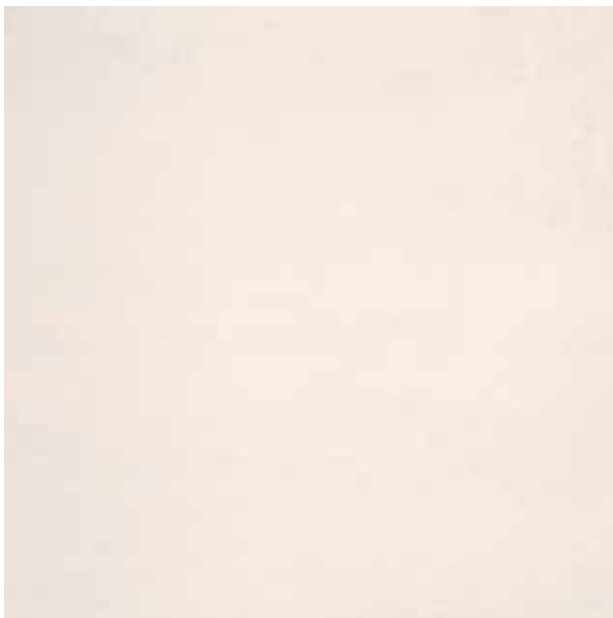

200V6060 € BP16

M cool porcelain white
 BP, TVG, HV

 RL
 R10 68



203V6060 € BP16

M cool black
 BP, 103VM, 103HM, TVG, HV

 RL
 R10 8



204V6060 € BP16

M mid warm grey
 304SP, BP, 104VM, 104HM, TVG, HV

 RL
 R10 22



206V6060 € BP16

M mid grey
 306SP, BP, TVG, HV

 RL
 R10 34



Core Collection Terra

vloertegels / carreaux de sol / Bodenfliesen / floor tiles
 Ultragres ongeglazuurd / non émaillé / unglasiert / unglazed
 vorstbestand / ingélif / frostsicher / frost proof

no.	mm	inch	pieces/ m ²	pieces/ m ¹	pieces/ box	boxes/ pallet	pieces/ pallet	m ² / pallet	kg/ m ²	kg/ pallet
211V - 216V	597x597x12	23.50x23.50x0.47	2,8	-	3 = 1,071 m ²	30	90	32,1	27,8	918

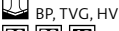

211V6060 

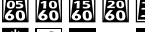
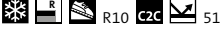
 avalon beige

 RL







214V6060 

 grey





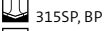

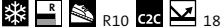

215V6060 

 grey green

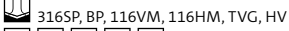



216V6060 

 anthracite

 RL





Core Collection Terra

vloertegels / carreaux de sol / Bodenfliesen / floor tiles
 Ultragres ongeglazuurd / non émaillé / unglasiert / unglazed
 vorstbestand / ingélif / frostsicher / frost proof

no.	mm	inch	pieces/ m ²	pieces/ m ¹	pieces/ box	boxes/ pallet	pieces/ pallet	m ² / pallet	kg/ m ²	kg/ pallet
222V - 227V	597x597x12	23.50x23.50x0.47	2,8	-	3 = 1,071 m ²	30	90	32,1	27,8	918





222V6060  BP16

 mid moss-grey
 BP

 R10 C2C 25

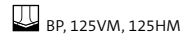



225V6060  BP16

 light cool grey
 BP, 125VM, 125HM

 R10 C2C 40



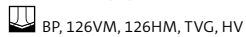

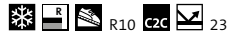

226V6060  BP16

 mid cool grey
 BP, 126VM, 126HM, TVG, HV

 R10 C2C 23



227V6060  BP16

 dark cool grey
 BP, TVG, HV

 R10 C2C 14

60 Core Collection Terra

vloertegels / carreaux de sol / Bodenfliesen / floor tiles
 Ultragres ongeglazuurd / non émaillé / unglasiert / unglazed
 vorstbestand / ingélif / frostsicher / frost proof

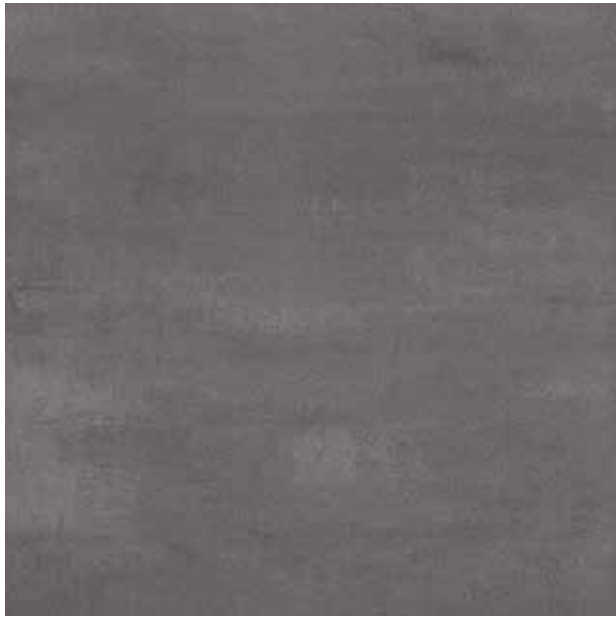
no.	mm	inch	pieces/ m ²	pieces/ m ¹	pieces/ box	boxes/ pallet	pieces/ pallet	m ² / pallet	kg/ m ²	kg/ pallet
229V - 262V	597x597x12	23.50x23.50x0.47	2,8	-	3 = 1,071 m ²	30	90	32,1	27,8	918



229V6060 € BP16

M dark warm grey
 BP, TVG, HV

 14



238V6060 € BP16

M cool grey
 BP

 31



239V6060 € BP16

M blue
 BP

 12



262V6060 € BP16

M light grey beige
 362SP, BP, TVG, HV

 61

60 60 Core Collection Terra

vloertegels / carreaux de sol / Bodenfliesen / floor tiles
 Ultragres ongeglazuurd / non émaillé / unglasiert / unglazed
 vorstbestand / ingélif / frostsicher / frost proof

no.	mm	inch	pieces/ m ²	pieces/ m ¹	pieces/ box	boxes/ pallet	pieces/ pallet	m ² / pallet	kg/ m ²	kg/ pallet
263V - 266V	597x597x12	23.50x23.50x0.47	2,8	-	3 = 1,071 m ²	30	90	32,1	27,8	918



263V6060 € BP16

M grey beige
 BP

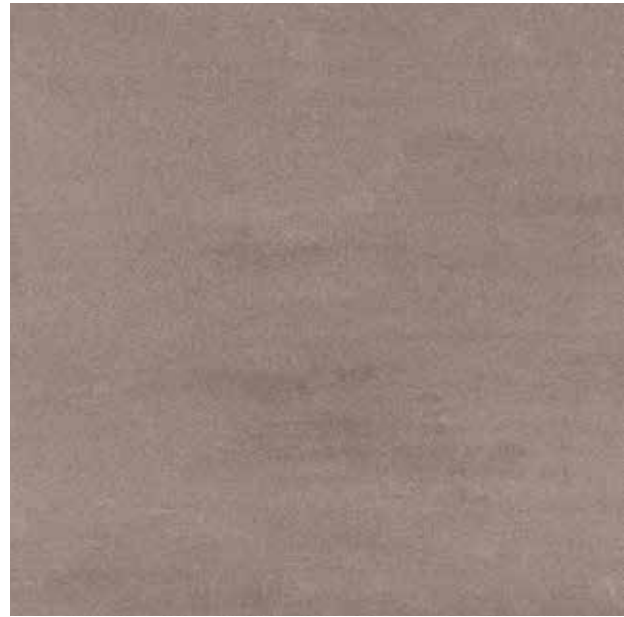

264V6060 € BP16

M grey brown
 BP, 164VM, 164HM



265V6060 € BP16

M dark grey brown
 BP, TVG



266V6060 € BP16

M light beige
 BP, 166VM, 166HM

Core Collection Terra

vloertegels / carreaux de sol / Bodenfliesen / floor tiles
 Ultragres ongeglazuurd / non émaillé / unglasiert / unglazed
 vorstbestand / ingélif / frostsicher / frost proof

no.	mm	inch	pieces/ m ²	pieces/ m ¹	pieces/ box	boxes/ pallet	pieces/ pallet	m ² / pallet	kg/ m ²	kg/ pallet
270V	597x597x12	23.50x23.50x0.47	2,8	-	3 = 1,071 m ²	30	90	32,1	27,8	918

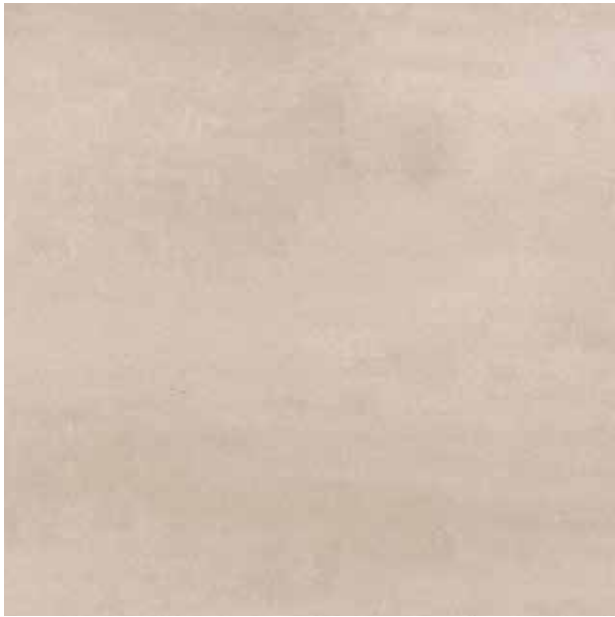

270V6060  BP16



light red beige



BP





Mosa Stage

vloertegels / carreaux de sol / Bodenfliesen / floor tiles
 Ultragres ongeglazuurd / non émaillé / unglasiert / unglazed
 vorstbestand / ingélif / frostsicher / frost proof

no.	mm	inch	pieces/ m ²	pieces/ m ¹	pieces/ box	boxes/ pallet	pieces/ pallet	m ² / pallet	kg/ m ²	kg/ pallet
3502CR - 3508CR	597x597x12	23.50x23.50x0.47	2,8	-	3 = 1,071 m ²	30	90	32,1	27,8	918











3502CR6060  BP15

 cool white
 BP, TCG
 
    60







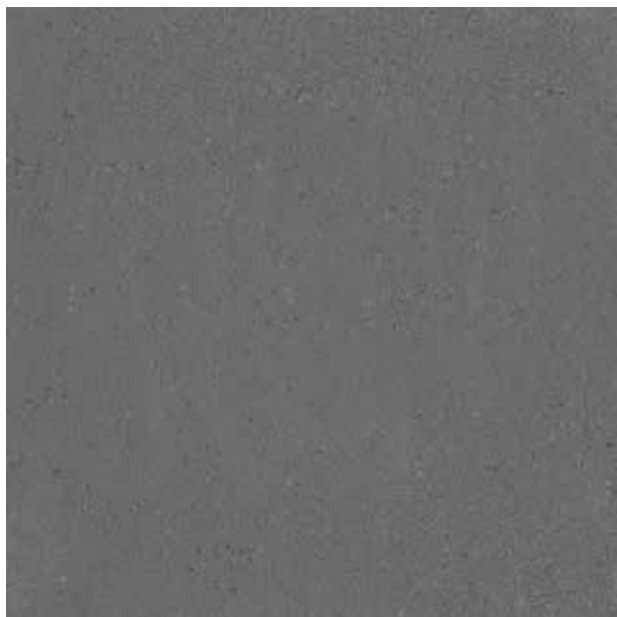



3504CR6060  BP15

 light cool grey
 BP, TCG
 
    38











3506CR6060  BP15

 dark cool grey
 BP, TCG
 
    17



3508CR6060  BP15

 light warm grey
 BP, TCG
 
    42





Mosa Stage

vloertegels / carreaux de sol / Bodenfliesen / floor tiles
 Ultragres ongeglazuurd / non émaillé / unglasiert / unglazed
 vorstbestand / ingélif / frostsicher / frost proof

no.	mm	inch	pieces/ m ²	pieces/ m ¹	pieces/ box	boxes/ pallet	pieces/ pallet	m ² / pallet	kg/ m ²	kg/ pallet
3510CR - 3516CR	597x597x12	23.50x23.50x0.47	2,8	-	3 = 1,071 m ²	30	90	32,1	27,8	918





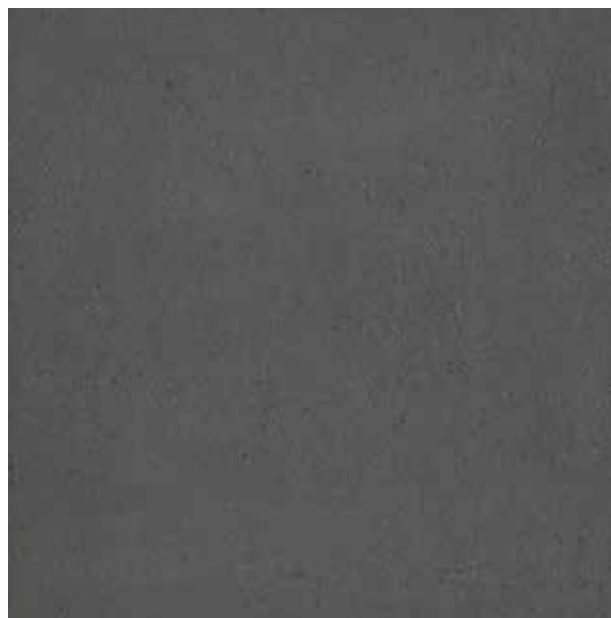

3510CR6060 

 mid warm grey









3512CR6060 

 dark plum brown









3514CR6060 

 sienna beige





3516CR6060 

 paynes grey





Mosa Stage

vloertegels / carreaux de sol / Bodenfliesen / floor tiles
 Ultragres ongeglazuurd / non émaillé / unglasiert / unglazed
 vorstbestand / ingélif / frostsicher / frost proof

no.	mm	inch	pieces/ m ²	pieces/ m ¹	pieces/ box	boxes/ pallet	pieces/ pallet	m ² / pallet	kg/ m ²	kg/ pallet
3518CR	597x597x12	23.50x23.50x0.47	2,8	-	3 = 1,071 m ²	30	90	32,1	27,8	918







3518CR6060  BP15

 ivory black

 BP, TCG

    R10 B C2C 8











Terra Tones

vloertegels / carreaux de sol / Bodenfliesen / floor tiles
 Ultragres ongeglazuurd / non émaillé / unglasiert / unglazed
 vorstbestand / ingélif / frostsicher / frost proof

no.	mm	inch	pieces/ m ²	pieces/ m ¹	pieces/ box	boxes/ pallet	pieces/ pallet	m ² / pallet	kg/ m ²	kg/ pallet
200XV - 200ZV	597x597x12	23.50x23.50x0.47	2,8	-	3 = 1,071 m ²	30	90	32,1	27,8	918



200XV6060 
 200YV6060
 200ZV6060

 cool porcelain white
 BP, TVG, HV

  
    R10 C2C 68

Terra Tones

vloertegels / carreaux de sol / Bodenfliesen / floor tiles
 Ultragres ongeglazuurd / non émaillé / unglasiert / unglazed
 vorstbestand / ingélif / frostsicher / frost proof

no.	mm	inch	pieces/ m ²	pieces/ m ¹	pieces/ box	boxes/ pallet	pieces/ pallet	m ² / pallet	kg/ m ²	kg/ pallet
203XV - 203ZV	597x597x12	23.50x23.50x0.47	2,8	-	3 = 1,071 m ²	30	90	32,1	27,8	918



203XV6060  AP01

203YV6060

203ZV6060



cool black



BP, 103VM, 103HM, TVG, HV



R10 C2C 8

Terra Tones

vloertegels / carreaux de sol / Bodenfliesen / floor tiles
 Ultragres ongeglazuurd / non émaillé / unglasiert / unglazed
 vorstbestand / ingélif / frostsicher / frost proof

no.	mm	inch	pieces/ m ²	pieces/ m ¹	pieces/ box	boxes/ pallet	pieces/ pallet	m ² / pallet	kg/ m ²	kg/ pallet
206XV - 206ZV	597x597x12	23.50x23.50x0.47	2,8	-	3 = 1,071 m ²	30	90	32,1	27,8	918



206XV6060 
 206YV6060
 206ZV6060

 mid grey
 306SP, BP, TVG, HV

  
   R10 c2c 34

Terra Tones

vloertegels / carreaux de sol / Bodenfliesen / floor tiles
 Ultragres ongeglazuurd / non émaillé / unglasiert / unglazed
 vorstbestand / ingélif / frostsicher / frost proof

no.	mm	inch	pieces/ m ²	pieces/ m ¹	pieces/ box	boxes/ pallet	pieces/ pallet	m ² / pallet	kg/ m ²	kg/ pallet
215XV - 215ZV	597x597x12	23.50x23.50x0.47	2,8	-	3 = 1,071 m ²	30	90	32,1	27,8	918



215XV6060  AP01

215YV6060

215ZV6060



grey green



315SP, BP



   R10 C2C 18

Voor tegelpatronen zie generator.mosa.com.
 Pour des motifs de carreaux, visitez generator.mosa.com.
 Für Verlegemuster siehe generator.mosa.com.
 For tile patterns see generator.mosa.com.

Terra Tones

vloertegels / carreaux de sol / Bodenfliesen / floor tiles
 Ultragres ongeglazuurd / non émaillé / unglasiert / unglazed
 vorstbestand / ingélif / frostsicher / frost proof

no.	mm	inch	pieces/ m ²	pieces/ m ¹	pieces/ box	boxes/ pallet	pieces/ pallet	m ² / pallet	kg/ m ²	kg/ pallet
216XV - 216ZV	597x597x12	23.50x23.50x0.47	2,8	-	3 = 1,071 m ²	30	90	32,1	27,8	918

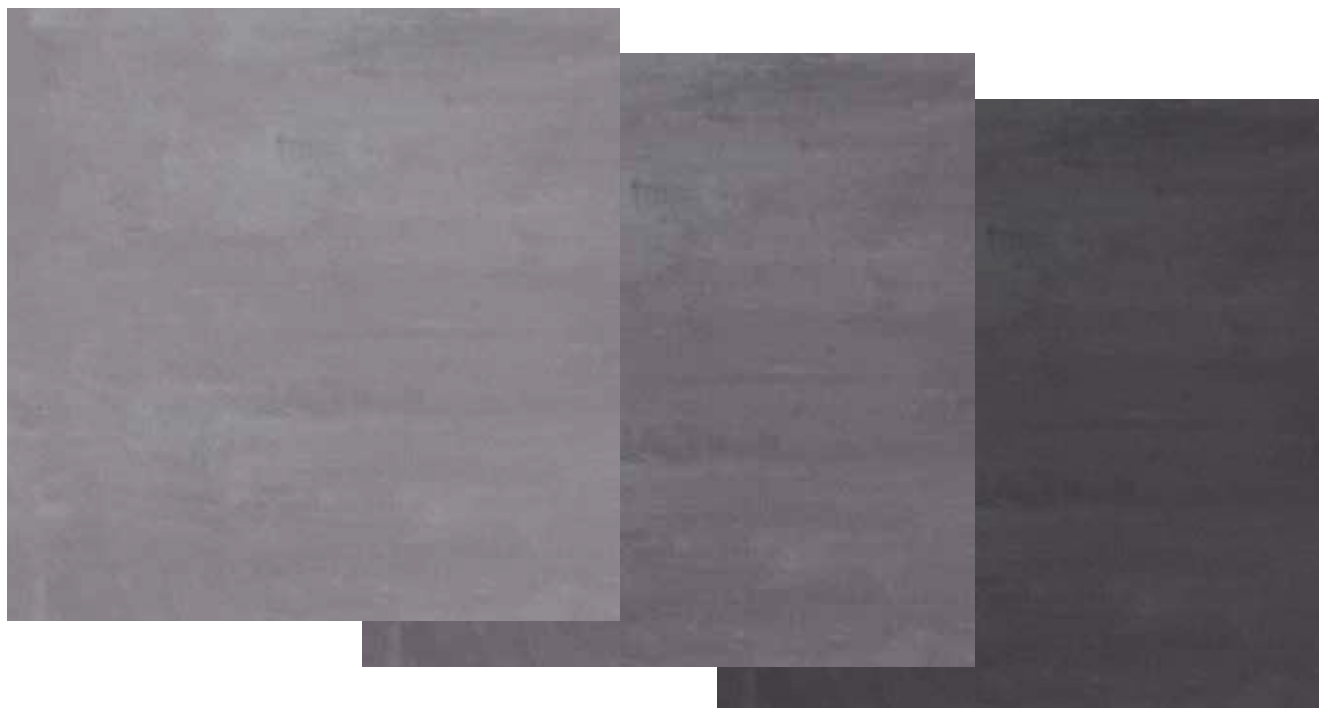

216XV6060  AP01

216YV6060

216ZV6060

 anthracite

 316SP, BP, 116VM, 116HM, TVG, HV









 R10   12

60 Terra Tones

vloertegels / carreaux de sol / Bodenfliesen / floor tiles
 Ultragres ongeglazuurd / non émaillé / unglasiert / unglazed
 vorstbestand / ingélif / frostsicher / frost proof

no.	mm	inch	pieces/ m ²	pieces/ m ¹	pieces/ box	boxes/ pallet	pieces/ pallet	m ² / pallet	kg/ m ²	kg/ pallet
266XV - 266ZV	597x597x12	23.50x23.50x0.47	2,8	-	3 = 1,071 m ²	30	90	32,1	27,8	918



266XV6060 € AP01

266YV6060

266ZV6060

M light beige

BP, 166VM, 166HM



R10 C2C 49

Elke kleurgroep telt lichte (X), midden (Y) en donkere (Z) tonen. Per kleurgroep worden, per formaat, willekeurige hoeveelheden van X, Y en Z geleverd.
 Chaque groupe de couleur compte des tons clairs (X), moyens (Y) et foncés (Z). Les quantités aléatoires de X, Y et Z sont fournies par format et par groupe de couleur.
 Jede Farbgruppe enthält helle (X), mittlere (Y) und dunkle (Z) Töne. Pro Farbgruppe sind pro Format zufälligen Mengen von X, Y und Z erhältlich.
 Each colour group has light (X), medium (Y), and dark (Z) shades. For each colour group and size, random quantities of X, Y, and Z are supplied.

Voor uitgebreide verwerkingsadviezen zie www.mosa.com.
 On peut trouver toutes les directives de pose sur www.mosa.com.
 Für komplette Hinweise zur Verarbeitung siehe www.mosa.com.
 The complete guidelines for installation can be found on www.mosa.com.



Core Collection Terra

vloertegels / carreaux de sol / Bodenfliesen / floor tiles
 Ultragres ongeglazuurd / non émaillé / unglasiert / unglazed
 vorstbestand / ingélif / frostsicher / frost proof

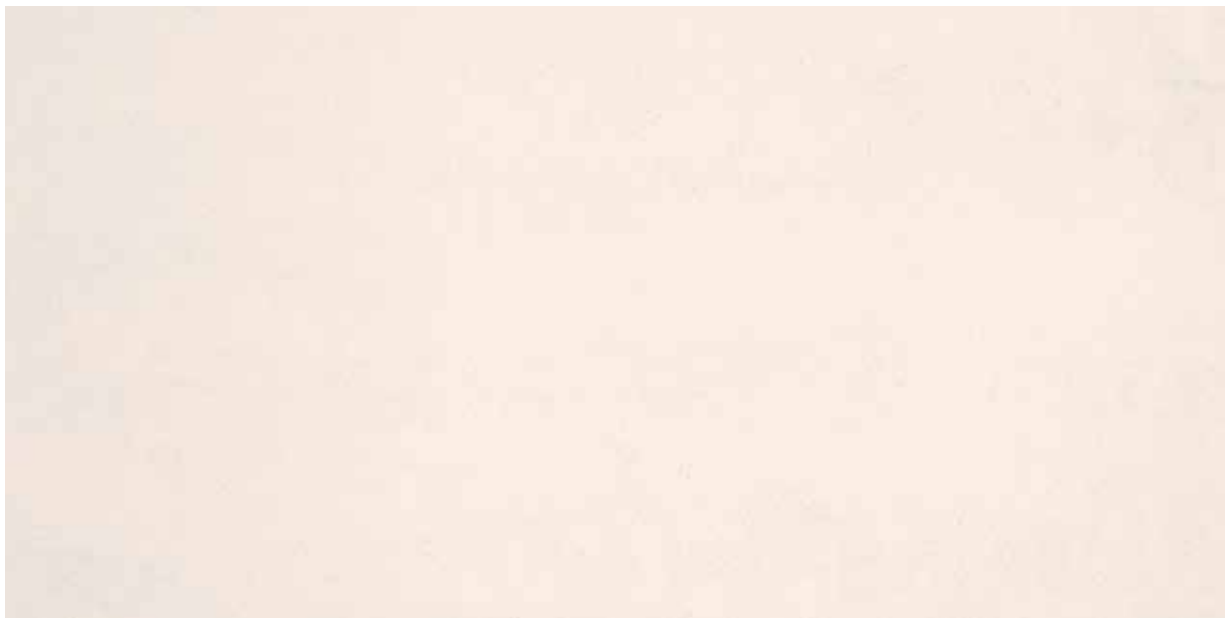
no.	mm	inch	pieces/ m ²	pieces/ m ¹	pieces/ box	boxes/ pallet	pieces/ pallet	m ² / pallet	kg/ m ²	kg/ pallet
200V - 203V	597x1197x13	23.50x47.13x0.51	1,4	-	1 = 0,714 m ²	35	35	25,0	30,5	787



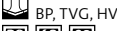

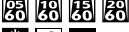
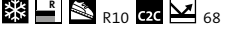
200V60120 

-  cool porcelain white
-  BP, TVG, HV
-  60 60 90
-  60 10 15 30
-  R10 C2C 68

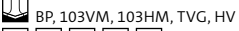

203V60120 

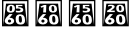
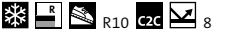
-  cool black
-  BP, 103VM, 103HM, TVG, HV
-  15 30 60 90
-  60 10 15 30
-  R10 C2C 8



Core Collection Terra

vloertegels / carreaux de sol / Bodenfliesen / floor tiles
Ultragres oneglazuurd / non émaillé / unglasiert / unglazed
vorstbestand / ingélif / frostsicher / frost proof

no.	mm	inch	pieces/ m ²	pieces/ m ¹	pieces/ box	boxes/ pallet	pieces/ pallet	m ² / pallet	kg/ m ²	kg/ pallet
204V - 206V	597x1197x13	23.50x47.13x0.51	1,4	-	1 = 0,714 m ²	35	35	25,0	30,5	787



204V60120 BP13



mid warm grey



304SP, BP, 104VM, 104HM, TVG, HV



206V60120 BP13



mid grey



306SP, BP, TVG, HV





Core Collection Terra

vloertegels / carreaux de sol / Bodenfliesen / floor tiles
 Ultragres ongeglazuurd / non émaillé / unglasiert / unglazed
 vorstbestand / ingélif / frostsicher / frost proof

no.	mm	inch	pieces/ m ²	pieces/ m ¹	pieces/ box	boxes/ pallet	pieces/ pallet	m ² / pallet	kg/ m ²	kg/ pallet
211V - 216V	597x1197x13	23.50x47.13x0.51	1,4	-	1 = 0,714 m ²	35	35	25,0	30,5	787





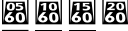
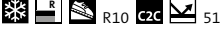

211V60120 

 avalon beige
 BP, TVG, HV

 R10 C2C 51

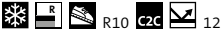

216V60120 

 anthracite
 316SP, BP, 116VM, 116HM, TVG, HV

 R10 C2C 12







Core Collection Terra

vloertegels / carreaux de sol / Bodenfliesen / floor tiles
 Ultragres ongeglazuurd / non émaillé / unglasiert / unglazed
 vorstbestand / ingélif / frostsicher / frost proof

no.	mm	inch	pieces/ m ²	pieces/ m ¹	pieces/ box	boxes/ pallet	pieces/ pallet	m ² / pallet	kg/ m ²	kg/ pallet
225V - 226V	597x1197x13	23.50x47.13x0.51	1,4	-	1 = 0,714 m ²	35	35	25,0	30,5	787







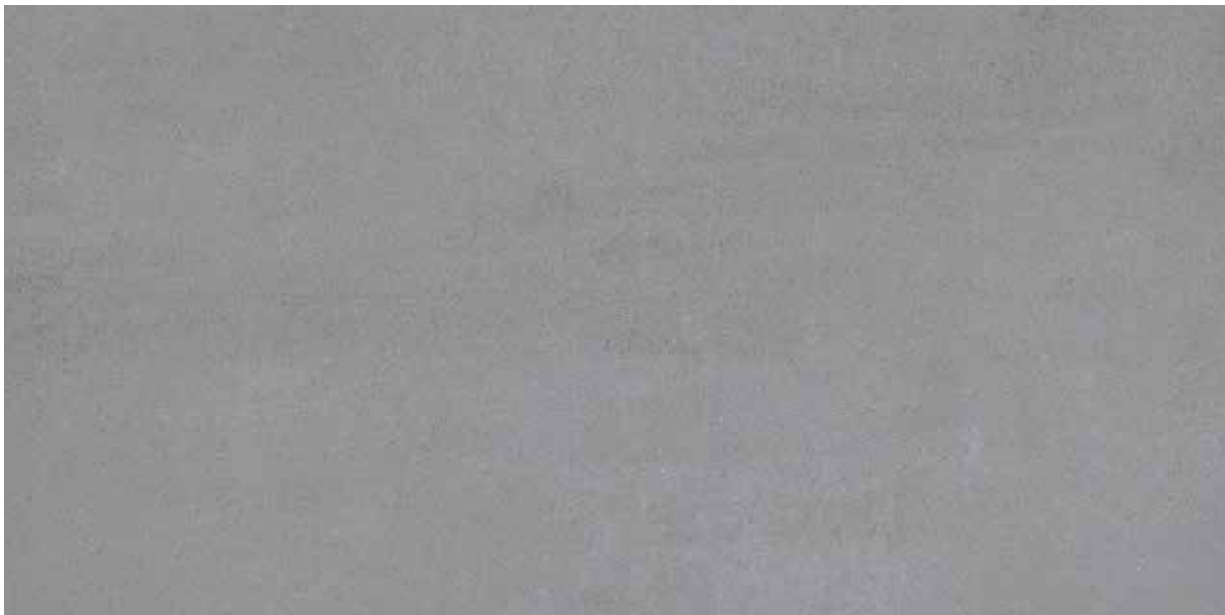







225V60120  BP13

 light cool grey
 BP, 125VM, 125HM
 T3  50  60  60  60
 60  60  60
 R10  C2C  40



226V60120  BP13

 mid cool grey
 BP, 126VM, 126HM, TVG, HV
 T3  50  60  60
 60  60  60
 R10  C2C  23











Core Collection Terra

vloertegels / carreaux de sol / Bodenfliesen / floor tiles
 Ultragres ongeglazuurd / non émaillé / unglasiert / unglazed
 vorstbestand / ingélif / frostsicher / frost proof

no.	mm	inch	pieces/ m ²	pieces/ m ¹	pieces/ box	boxes/ pallet	pieces/ pallet	m ² / pallet	kg/ m ²	kg/ pallet
227V - 229V	597x1197x13	23.50x47.13x0.51	1,4	-	1 = 0,714 m ²	35	35	25,0	30,5	787











227V60120 

-  dark cool grey
-  BP, TVG, HV
-   
-   
-   



229V60120 

-  dark warm grey
-  BP, TVG, HV
-   
-   
-



Core Collection Terra

vloertegels / carreaux de sol / Bodenfliesen / floor tiles
Ultragres oneglazuurd / non émaillé / unglasiert / unglazed
vorstbestand / ingélif / frostsicher / frost proof

no.	mm	inch	pieces/ m ²	pieces/ m ¹	pieces/ box	boxes/ pallet	pieces/ pallet	m ² / pallet	kg/ m ²	kg/ pallet
262V - 265V	597x1197x13	23.50x47.13x0.51	1,4	-	1 = 0,714 m ²	35	35	25,0	30,5	787



262V60120 BP13

light grey beige
 362SP, BP, TVG, HV
 60 60 60
 60 60 60 60
 R10 C2C 61



265V60120 BP13

dark grey brown
 BP, TVG
 60 60
 60 60 60 60
 R10 C2C 9

Voor de bijbehorende reliëftegelcollectie Core Collection Terra in dit formaat zie pagina's 165 - 167.
 Pour la collection en relief correspondante Core Collection Terra dans ce format voir pages 165 - 167.
 Für die dazugehörige Reliefkollektion Core Collection Terra in diesen Format siehe Seiten 165 - 167.
 For the matching Core Collection Terra relief tiles in this size see pages 165 - 167.

Voor tegelpatronen zie generator.mosa.com.
 Pour des motifs de carreaux, visitez generator.mosa.com.
 Für Verlegemuster siehe generator.mosa.com.
 For tile patterns see generator.mosa.com.











Core Collection Solids

vloertegels / carreaux de sol / Bodenfliesen / floor tiles
 Ultragres ongeglazuurd / non émaillé / unglasiert / unglazed
 vorstbestand / ingélif / frostsicher / frost proof

no.	mm	inch	pieces/ m ²	pieces/ m ¹	pieces/ box	boxes/ pallet	pieces/ pallet	m ² / pallet	kg/ m ²	kg/ pallet
5102V - 5108V	897x897x13	35.31x35.31x0.51	1,23	-	1 = 0,813 m ²	36	36	29,3	30,2	909







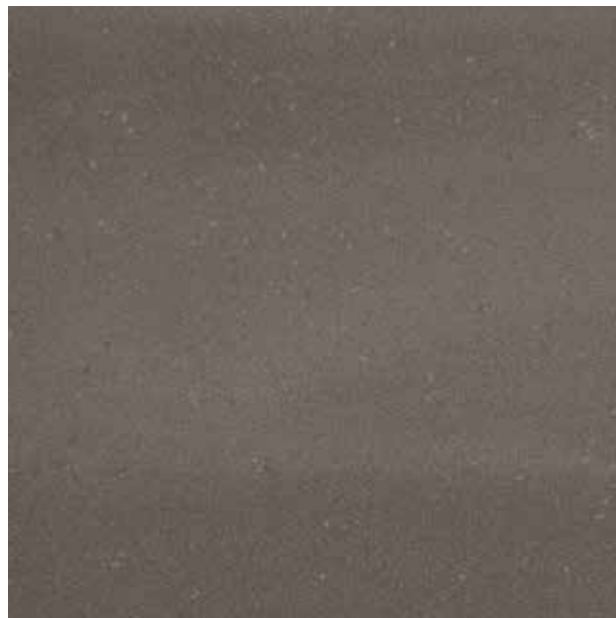



5102V9090 

 vivid white
 5002SP, BP, TVG, HV
 
  
    R10 C2C 58











5104V9090 

 clay grey
 BP, TVG, HV
 
    R10 C2C 28













5106V9090 

 agate grey
 5006SP, BP, TVG, HV
 
    R10 C2C 15



5108V9090 

 stone grey
 5008SP, BP, TVG, HV
 
  
    R10 C2C 33





Core Collection Solids

vloertegels / carreaux de sol / Bodenfliesen / floor tiles
 Ultragres ongeglazuurd / non émaillé / unglasiert / unglazed
 vorstbestand / ingélif / frostsicher / frost proof

no.	mm	inch	pieces/ m ²	pieces/ m ¹	pieces/ box	boxes/ pallet	pieces/ pallet	m ² / pallet	kg/ m ²	kg/ pallet
5110V - 5112V	897x897x13	35.31x35.31x0.51	1,23	-	1 = 0,813 m ²	36	36	29,3	30,2	909









5110V9090  BP02

 basalt grey
 5010SP, BP, TVG, HV

 R10 C2C  16



5112V9090  BP02

 graphite black
 BP, TVG, HV

 R10 C2C  10

90/90 Core Collection Terra

vloertegels / carreaux de sol / Bodenfliesen / floor tiles
 Ultragres ongeglazuurd / non émaillé / unglasiert / unglazed
 vorstbestand / ingélf / frostsicher / frost proof

no.	mm	inch	pieces/ m ²	pieces/ m ¹	pieces/ box	boxes/ pallet	pieces/ pallet	m ² / pallet	kg/ m ²	kg/ pallet
200V - 206V	897x897x13	35.31x35.31x0.51	1,23	-	1 = 0,813 m ²	36	36	29,3	30,2	909



200V9090 € BP13

M cool porcelain white
 BP, TVG, HV

 R10 C2C 68



203V9090 € BP13

M cool black
 BP, 103VM, 103HM, TVG, HV

 R10 C2C 8



204V9090 € BP13

M mid warm grey
 304SP, BP, 104VM, 104HM, TVG, HV

 R10 C2C 22



206V9090 € BP13

M mid grey
 306SP, BP, TVG, HV

 R10 C2C 34



Core Collection Terra

vloertegels / carreaux de sol / Bodenfliesen / floor tiles
 Ultragres ongeglazuurd / non émaillé / unglasiert / unglazed
 vorstbestand / ingélif / frostsicher / frost proof

no.	mm	inch	pieces/ m ²	pieces/ m ¹	pieces/ box	boxes/ pallet	pieces/ pallet	m ² / pallet	kg/ m ²	kg/ pallet
216V - 229V	897x897x13	35.31x35.31x0.51	1,23	-	1 = 0,813 m ²	36	36	29,3	30,2	909



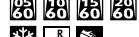
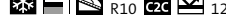

216V9090 

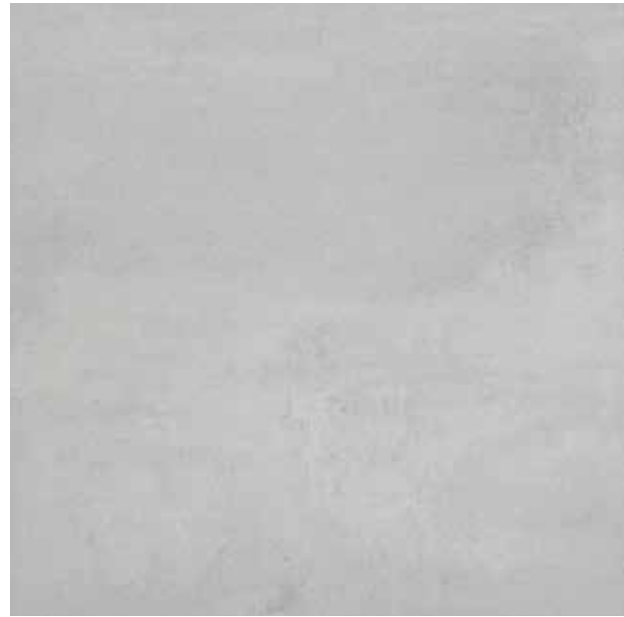
 anthracite
 316SP, BP, 116VM, 116HM, TVG, HV

 R10 C2C 12

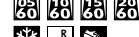





225V9090 

 light cool grey
 BP, 125VM, 125HM

 R10 C2C 40







226V9090 

 mid cool grey
 BP, 126VM, 126HM, TVG, HV

 R10 C2C 23

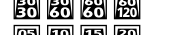

229V9090 

 dark warm grey
 BP, TVG, HV

 R10 C2C 14









Core Collection Terra

vloertegels / carreaux de sol / Bodenfliesen / floor tiles
 Ultragres ongeglazuurd / non émaillé / unglasiert / unglazed
 vorstbestand / ingélif / frostsicher / frost proof

no.	mm	inch	pieces/ m ²	pieces/ m ¹	pieces/ box	boxes/ pallet	pieces/ pallet	m ² / pallet	kg/ m ²	kg/ pallet
262V	897x897x13	35.31x35.31x0.51	1,23	-	1 = 0,813 m ²	36	36	29,3	30,2	909



262V9090  BP13

 light grey beige
 362SP, BP, TVG, HV
 
    



Mosa Stage

vloertegels / carreaux de sol / Bodenfliesen / floor tiles
 Ultragres ongeglazuurd / non émaillé / unglasiert / unglazed
 vorstbestand / ingélif / frostsicher / frost proof

no.	mm	inch	pieces/ m ²	pieces/ m ¹	pieces/ box	boxes/ pallet	pieces/ pallet	m ² / pallet	kg/ m ²	kg/ pallet
3502CR - 3508CR	897x897x13	35.31x35.31x0.51	1,23	-	1 = 0,813 m ²	36	36	29,3	30,2	909









3502CR9090  BP12

 cool white
 BP, TCG
 60
 R10  B  C2C  60







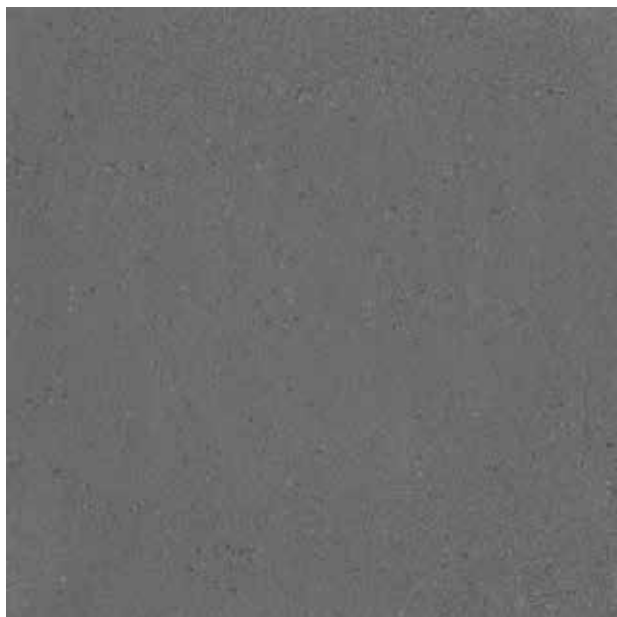

3504CR9090  BP12

 light cool grey
 BP, TCG
 60
 R10  B  C2C  38









3506CR9090  BP12

 dark cool grey
 BP, TCG
 60
 R10  B  C2C  17



3508CR9090  BP12

 light warm grey
 BP, TCG
 60
 R10  B  C2C  42





Mosa Stage

vloertegels / carreaux de sol / Bodenfliesen / floor tiles
 Ultragres ongeglazuurd / non émaillé / unglasiert / unglazed
 vorstbestand / ingélif / frostsicher / frost proof

no.	mm	inch	pieces/ m ²	pieces/ m ¹	pieces/ box	boxes/ pallet	pieces/ pallet	m ² / pallet	kg/ m ²	kg/ pallet
3510CR - 3516CR	897x897x13	35.31x35.31x0.51	1,23	-	1 = 0,813 m ²	36	36	29,3	30,2	909





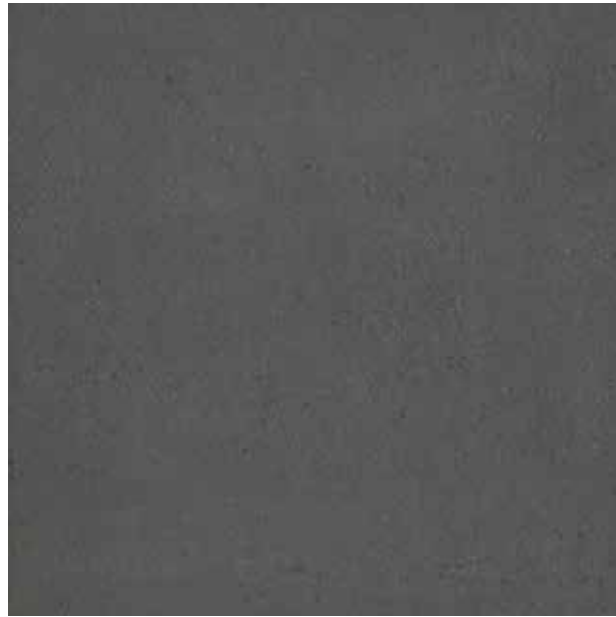

3510CR9090  BP12

 mid warm grey









3512CR9090  BP12

 dark plum brown









3514CR9090  BP12

 sienna beige





3516CR9090  BP12

 paynes grey





Mosa Stage

vloertegels / carreaux de sol / Bodenfliesen / floor tiles
 Ultragres ongeglazuurd / non émaillé / unglasiert / unglazed
 vorstbestand / ingélif / frostsicher / frost proof

no.	mm	inch	pieces/ m ²	pieces/ m ¹	pieces/ box	boxes/ pallet	pieces/ pallet	m ² / pallet	kg/ m ²	kg/ pallet
3518CR	897x897x13	35.31x35.31x0.51	1,23	-	1 = 0,813 m ²	36	36	29,3	30,2	909



3518CR9090  BP12

 ivory black

 BP, TCG

 60

    8

Voor tegelpatronen zie generator.mosa.com.
 Pour des motifs de carreaux, visitez generator.mosa.com.
 Für Verlegemuster siehe generator.mosa.com.
 For tile patterns see generator.mosa.com.



Core Collection Solids

vloertegels / carreaux de sol / Bodenfliesen / floor tiles
Ultragres ongeglazuurd / non émaillé / unglasiert / unglazed
vorstbestand / ingélif / frostsicher / frost proof

no.	mm	inch	pieces/ m ²	pieces/ m ¹	pieces/ box	boxes/ pallet	pieces/ pallet	m ² / pallet	kg/ m ²	kg/ pallet
5102V - 5112V	97x597x12	3.82x23.50x0.47	16,7	-	6 = 0,36 m ²	108	648	38,8	27,2	1.080
5102V - 5112V	197x597x12	7.76x23.50x0.47	8,3	-	6 = 0,721 m ²	45	270	32,5	27,7	925
5102V - 5112V	397x597x12	15.63x23.50x0.47	4,16	-	3 = 0,72 m ²	45	135	32,5	26,3	880



5102V1060 (10x60 cm) € BP04
 5102V2060 (20x60 cm) € BP04
 5102V4060 (40x60 cm) € BP04

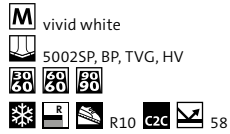

5108V1060 (10x60 cm) € BP04
 5108V2060 (20x60 cm) € BP04
 5108V4060 (40x60 cm) € BP04

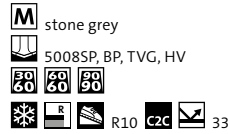

5110V1060 (10x60 cm) € BP04
 5110V2060 (20x60 cm) € BP04
 5110V4060 (40x60 cm) € BP04

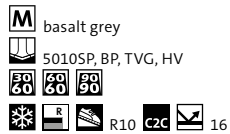

5112V1060 (10x60 cm) € BP04
 5112V2060 (20x60 cm) € BP04
 5112V4060 (40x60 cm) € BP04

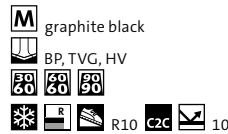

10 x 60 cm / 4 x 24 inch

20 x 60 cm / 8 x 24 inch

40 x 60 cm / 16 x 24 inch



Core Collection Solids

vloertegels / carreaux de sol / Bodenfliesen / floor tiles
 Ultragres ongeglazuurd / non émaillé / unglasiert / unglazed
 vorstbestand / ingélif / frostsicher / frost proof

no.	mm	inch	pieces/ m ²	pieces/ m ¹	pieces/ box	boxes/ pallet	pieces/ pallet	m ² / pallet	kg/ m ²	kg/ pallet
5120V - 5126V	97x597x12	3.82x23.50x0.47	16,7	-	6 = 0,36 m ²	108	648	38,8	27,2	1.080
5120V - 5126V	197x597x12	7.76x23.50x0.47	8,3	-	6 = 0,721 m ²	45	270	32,5	27,7	925
5120V - 5126V	397x597x12	15.63x23.50x0.47	4,16	-	3 = 0,72 m ²	45	135	32,5	26,3	880



- 5120V1060 (10x60 cm) € BP04
- 5120V2060 (20x60 cm) € BP04
- 5120V4060 (40x60 cm) € BP04



jade grey



5020SP, BP, TVG, HV



R10 C2C 25

- 5126V1060 (10x60 cm) € BP04
- 5126V2060 (20x60 cm) € BP04
- 5126V4060 (40x60 cm) € BP04



natural beige



BP, TVG, HV



R10 C2C 52

10 x 60 cm / 4 x 24 inch

20 x 60 cm / 8 x 24 inch

40 x 60 cm / 16 x 24 inch

Voor uitgebreide verwerkingsadviezen zie www.mosa.com.
 On peut trouver toutes les directives de pose sur www.mosa.com.
 Für komplette Hinweise zur Verarbeitung siehe www.mosa.com.
 The complete guidelines for installation can be found on www.mosa.com.

Core Collection Terra

vloertegels / carreaux de sol / Bodenfliesen / floor tiles
 Ultragres ongeglazuurd / non émaillé / unglasiert / unglazed
 vorstbestand / ingélif / frostsicher / frost proof

no.	mm	inch	pieces/ m ²	pieces/ m ¹	pieces/ box	boxes/ pallet	pieces/ pallet	m ² / pallet	kg/ m ²	kg/ pallet
200V - 216V	47x597x12	1.85x23.50x0.47	33,3	-	24 = 0,721 m ²	56	1.344	40,4	26,5	1.096
200V - 216V	97x597x12	3.82x23.50x0.47	16,7	-	12 = 0,721 m ²	56	672	40,4	27,2	1.119
200V - 216V	147x597x12	5.79x23.50x0.47	11,1	-	8 = 0,721 m ²	56	448	40,4	27,0	1.115
200V - 216V	197x597x12	7.76x23.50x0.47	8,3	-	6 = 0,721 m ²	45	270	32,5	27,7	925

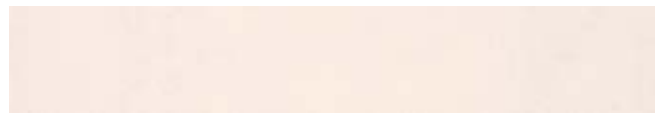

200V560	(5x60 cm)	€ BP17
200V1060	(10x60 cm)	€ BP17
200V1560	(15x60 cm)	€ BP17
200V2060	(20x60 cm)	€ BP17

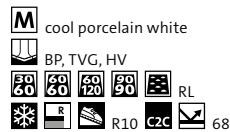

203V560	(5x60 cm)	€ BP17
203V1060	(10x60 cm)	€ BP17
203V1560	(15x60 cm)	€ BP17
203V2060	(20x60 cm)	€ BP17

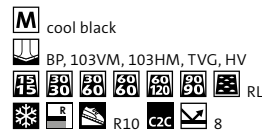

204V560	(5x60 cm)	€ BP17
204V1060	(10x60 cm)	€ BP17
204V1560	(15x60 cm)	€ BP17
204V2060	(20x60 cm)	€ BP17

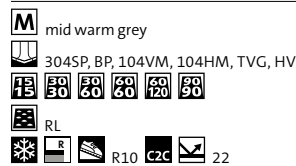

206V560	(5x60 cm)	€ BP17
206V1060	(10x60 cm)	€ BP17
206V1560	(15x60 cm)	€ BP17
206V2060	(20x60 cm)	€ BP17

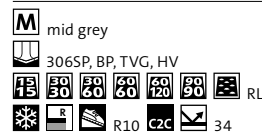

211V560	(5x60 cm)	€ BP17
211V1060	(10x60 cm)	€ BP17
211V1560	(15x60 cm)	€ BP17
211V2060	(20x60 cm)	€ BP17

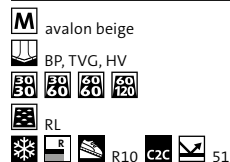

216V560	(5x60 cm)	€ BP17
216V1060	(10x60 cm)	€ BP17
216V1560	(15x60 cm)	€ BP17
216V2060	(20x60 cm)	€ BP17

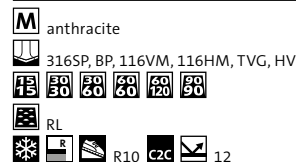

5 x 60 cm / 2 x 24 inch

10 x 60 cm / 4 x 24 inch

15 x 60 cm / 6 x 24 inch

20 x 60 cm / 8 x 24 inch



Core Collection Terra

vloertegels / carreaux de sol / Bodenfliesen / floor tiles
Ultragres ongeglazuurd / non émaillé / unglasiert / unglazed
vorstbestand / ingélif / frostsicher / frost proof

no.	mm	inch	pieces/ m ²	pieces/ m ¹	pieces/ box	boxes/ pallet	pieces/ pallet	m ² / pallet	kg/ m ²	kg/ pallet
222V - 239V	47x597x12	1.85x23.50x0.47	33,3	-	24 = 0,721 m ²	56	1.344	40,4	26,5	1.096
222V - 239V	97x597x12	3.82x23.50x0.47	16,7	-	12 = 0,721 m ²	56	672	40,4	27,2	1.119
222V - 239V	147x597x12	5.79x23.50x0.47	11,1	-	8 = 0,721 m ²	56	448	40,4	27,0	1.115
222V - 239V	197x597x12	7.76x23.50x0.47	8,3	-	6 = 0,721 m ²	45	270	32,5	27,7	925



- 222V560 (5x60 cm) € BP17
- 222V1060 (10x60 cm) € BP17
- 222V1560 (15x60 cm) € BP17
- 222V2060 (20x60 cm) € BP17

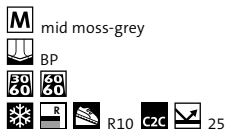

- 225V560 (5x60 cm) € BP17
- 225V1060 (10x60 cm) € BP17
- 225V1560 (15x60 cm) € BP17
- 225V2060 (20x60 cm) € BP17

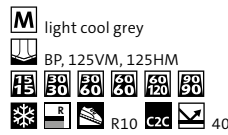

- 226V560 (5x60 cm) € BP17
- 226V1060 (10x60 cm) € BP17
- 226V1560 (15x60 cm) € BP17
- 226V2060 (20x60 cm) € BP17

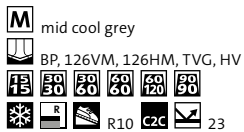

- 227V560 (5x60 cm) € BP17
- 227V1060 (10x60 cm) € BP17
- 227V1560 (15x60 cm) € BP17
- 227V2060 (20x60 cm) € BP17

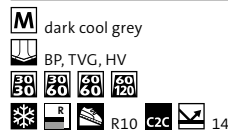

- 229V560 (5x60 cm) € BP17
- 229V1060 (10x60 cm) € BP17
- 229V1560 (15x60 cm) € BP17
- 229V2060 (20x60 cm) € BP17

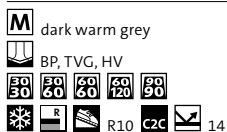

- 239V560 (5x60 cm) € BP17
- 239V1060 (10x60 cm) € BP17
- 239V1560 (15x60 cm) € BP17
- 239V2060 (20x60 cm) € BP17

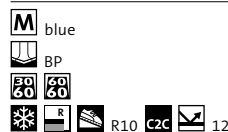

5 x 60 cm / 2 x 24 inch

10 x 60 cm / 4 x 24 inch

15 x 60 cm / 6 x 24 inch

20 x 60 cm / 8 x 24 inch







Core Collection Terra

vloertegels / carreaux de sol / Bodenfliesen / floor tiles
 Ultragres ongeglazuurd / non émaillé / unglasiert / unglazed
 vorstbestand / ingélif / frostsicher / frost proof

no.	mm	inch	pieces/ m ²	pieces/ m ¹	pieces/ box	boxes/ pallet	pieces/ pallet	m ² / pallet	kg/ m ²	kg/ pallet
262V - 270V	47x597x12	1.85x23.50x0.47	33,3	-	12 = 0,36 m ²	108	1.296	38,9	26,5	1.058
262V - 270V	97x597x12	3.82x23.50x0.47	16,7	-	6 = 0,36 m ²	108	648	38,8	27,2	1.080
262V - 270V	147x597x12	5.79x23.50x0.47	11,1	-	8 = 0,721 m ²	56	448	40,4	27,0	1.115
262V - 270V	197x597x12	7.76x23.50x0.47	8,3	-	6 = 0,721 m ²	45	270	32,5	27,7	925









262V560	(5x60 cm)	€ BP17
262V1060	(10x60 cm)	€ BP17
262V1560	(15x60 cm)	€ BP17
262V2060	(20x60 cm)	€ BP17

 light grey beige
 362SP, BP, TVG, HV
   R10   61









263V560	(5x60 cm)	€ BP17
263V1060	(10x60 cm)	€ BP17
263V1560	(15x60 cm)	€ BP17
263V2060	(20x60 cm)	€ BP17

 grey beige
 BP
   R10   31









264V560	(5x60 cm)	€ BP17
264V1060	(10x60 cm)	€ BP17
264V1560	(15x60 cm)	€ BP17
264V2060	(20x60 cm)	€ BP17

 grey brown
 BP, 164VM, 164HM
   R10   15







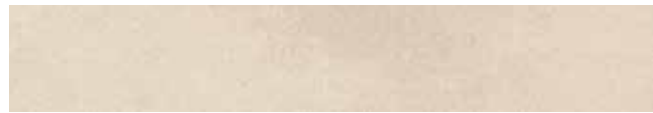

265V560	(5x60 cm)	€ BP17
265V1060	(10x60 cm)	€ BP17
265V1560	(15x60 cm)	€ BP17
265V2060	(20x60 cm)	€ BP17

 dark grey brown
 BP, TVG
   R10   9









266V560	(5x60 cm)	€ BP17
266V1060	(10x60 cm)	€ BP17
266V1560	(15x60 cm)	€ BP17
266V2060	(20x60 cm)	€ BP17

 light beige
 BP, 166VM, 166HM
   R10   49



270V560	(5x60 cm)	€ BP17
270V1060	(10x60 cm)	€ BP17
270V1560	(15x60 cm)	€ BP17
270V2060	(20x60 cm)	€ BP17

 light red beige
 BP
   R10   40

5 x 60 cm / 2 x 24 inch

10 x 60 cm / 4 x 24 inch

15 x 60 cm / 6 x 24 inch

20 x 60 cm / 8 x 24 inch

Voor uitgebreide verwerkingsadviezen zie www.mosa.com.
 On peut trouver toutes les directives de pose sur www.mosa.com.
 Für komplette Hinweise zur Verarbeitung siehe www.mosa.com.
 The complete guidelines for installation can be found on www.mosa.com.

Core Collection Terra

vloertegels / carreaux de sol / Bodenfliesen / floor tiles
 Ultragres ongeglazuurd / non émaillé / unglasiert / unglazed
 vorstbestand / ingélif / frostsicher / frost proof

no.	mm	inch	pieces/ m ²	pieces/ m ¹	pieces/ box	boxes/ pallet	pieces/ pallet	m ² / pallet	kg/ m ²	kg/ pallet
200RL - 216RL	47x597x12	1.85x23.50x0.47	33,3	-	24 = 0,721 m ²	56	1.344	40,4	26,5	1.096
200RL - 216RL	97x597x12	3.82x23.50x0.47	16,7	-	12 = 0,721 m ²	56	672	40,4	27,2	1.119
200RL - 216RL	147x597x12	5.79x23.50x0.47	11,1	-	8 = 0,721 m ²	56	448	40,4	27,0	1.115
200RL - 216RL	197x597x12	7.76x23.50x0.47	8,3	-	6 = 0,721 m ²	45	270	32,5	27,7	925



- 200RL560 (5x60 cm) € BP17
- 200RL1060 (10x60 cm) € BP17
- 200RL1560 (15x60 cm) € BP17
- 200RL2060 (20x60 cm) € BP17

M cool porcelain white
 BP, TVG, HV

 R11 C C2C 68
 reliëftegels / carreaux en relief /
 Relieffliesen / relief tiles



- 203RL560 (5x60 cm) € BP17
- 203RL1060 (10x60 cm) € BP17
- 203RL1560 (15x60 cm) € BP17
- 203RL2060 (20x60 cm) € BP17

M cool black
 BP, 103VM, 103HM, TVG, HV

 R11 C C2C 9
 reliëftegels / carreaux en relief /
 Relieffliesen / relief tiles



- 204RL560 (5x60 cm) € BP17
- 204RL1060 (10x60 cm) € BP17
- 204RL1560 (15x60 cm) € BP17
- 204RL2060 (20x60 cm) € BP17

M mid warm grey
 304SP, BP, 104VM, 104HM, TVG, HV

 R11 C C2C 23
 reliëftegels / carreaux en relief /
 Relieffliesen / relief tiles



- 206RL560 (5x60 cm) € BP17
- 206RL1060 (10x60 cm) € BP17
- 206RL1560 (15x60 cm) € BP17
- 206RL2060 (20x60 cm) € BP17

M mid grey
 306SP, BP, TVG, HV

 R11 C C2C 36
 reliëftegels / carreaux en relief /
 Relieffliesen / relief tiles



- 211RL560 (5x60 cm) € BP17
- 211RL1060 (10x60 cm) € BP17
- 211RL1560 (15x60 cm) € BP17
- 211RL2060 (20x60 cm) € BP17

M avalon beige
 BP, TVG, HV

 R11 C C2C 53
 reliëftegels / carreaux en relief /
 Relieffliesen / relief tiles



- 216RL560 (5x60 cm) € BP17
- 216RL1060 (10x60 cm) € BP17
- 216RL1560 (15x60 cm) € BP17
- 216RL2060 (20x60 cm) € BP17

M anthracite
 316SP, BP, 116VM, 116HM, TVG, HV

 R11 C C2C 14
 reliëftegels / carreaux en relief /
 Relieffliesen / relief tiles

5 x 60 cm / 2 x 24 inch

10 x 60 cm / 4 x 24 inch

15 x 60 cm / 6 x 24 inch

20 x 60 cm / 8 x 24 inch

Voor uitgebreide verwerkingsadviezen zie www.mosa.com.
 On peut trouver toutes les directives de pose sur www.mosa.com.
 Für komplette Hinweise zur Verarbeitung siehe www.mosa.com.
 The complete guidelines for installation can be found on www.mosa.com.



Terra Tones

vloertegels / carreaux de sol / Bodenfliesen / floor tiles
 Ultragres ongeglazuurd / non émaillé / unglasiert / unglazed
 vorstbestand / ingélif / frostsicher / frost proof

no.	mm	inch	pieces/ m ²	pieces/ m ¹	pieces/ box	boxes/ pallet	pieces/ pallet	m ² / pallet	kg/ m ²	kg/ pallet
200XV - 203ZV	47x597x12	1.85x23.50x0.47	33,3	-	12 = 0,36 m ²	108	1.296	38,9	26,5	1.058
200XV - 203ZV	97x597x12	3.82x23.50x0.47	16,7	-	6 = 0,36 m ²	108	648	38,8	27,2	1.080
200XV - 203ZV	147x597x12	5.79x23.50x0.47	11,1	-	8 = 0,721 m ²	56	448	40,4	27,0	1.115



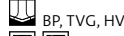

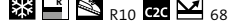
- 200XV560 (5x60 cm) € AP07
 200YV560
 200ZV560
 200XV1060 (10x60 cm) € AP07
 200YV1060
 200ZV1060
 200XV1560 (15x60 cm) € AP07
 200YV1560
 200ZV1560

 cool porcelain white
 BP, TVG, HV
 60 60
 R10 C2C 68

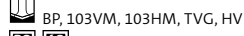

- 203XV560 (5x60 cm) € AP07
 203YV560
 203ZV560
 203XV1060 (10x60 cm) € AP07
 203YV1060
 203ZV1060
 203XV1560 (15x60 cm) € AP07
 203YV1560
 203ZV1560

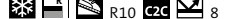
 cool black
 BP, 103VM, 103HM, TVG, HV
 60 60
 R10 C2C 8

5 x 60 cm / 2 x 24 inch
 10 x 60 cm / 4 x 24 inch
 15 x 60 cm / 6 x 24 inch



Terra Tones

vloertegels / carreaux de sol / Bodenfliesen / floor tiles
Ultragres ongeglazuurd / non émaillé / unglasiert / unglazed
vorstbestand / ingélif / frostsicher / frost proof

no.	mm	inch	pieces/ m ²	pieces/ m ¹	pieces/ box	boxes/ pallet	pieces/ pallet	m ² / pallet	kg/ m ²	kg/ pallet
206XV - 215ZV	47x597x12	1.85x23.50x0.47	33,3	-	12 = 0,36 m ²	108	1.296	38,9	26,5	1.058
206XV - 215ZV	97x597x12	3.82x23.50x0.47	16,7	-	6 = 0,36 m ²	108	648	38,8	27,2	1.080
206XV - 215ZV	147x597x12	5.79x23.50x0.47	11,1	-	8 = 0,721 m ²	56	448	40,4	27,0	1.115



- 206XV560 (5x60 cm) € AP07
- 206YV560
- 206ZV560
- 206XV1060 (10x60 cm) € AP07
- 206YV1060
- 206ZV1060
- 206XV1560 (15x60 cm) € AP07
- 206YV1560
- 206ZV1560

M mid grey
 306SP, BP, TVG, HV



- 215XV560 (5x60 cm) € AP07
- 215YV560
- 215ZV560
- 215XV1060 (10x60 cm) € AP07
- 215YV1060
- 215ZV1060
- 215XV1560 (15x60 cm) € AP07
- 215YV1560
- 215ZV1560

M grey green
 315SP, BP

- 5 x 60 cm / 2 x 24 inch
- 10 x 60 cm / 4 x 24 inch
- 15 x 60 cm / 6 x 24 inch







Terra Tones

vloertegels / carreaux de sol / Bodenfliesen / floor tiles
 Ultragres ongeglazuurd / non émaillé / unglasiert / unglazed
 vorstbestand / ingélif / frostsicher / frost proof

no.	mm	inch	pieces/ m ²	pieces/ m ¹	pieces/ box	boxes/ pallet	pieces/ pallet	m ² / pallet	kg/ m ²	kg/ pallet
216XV - 216ZV	47x597x12	1.85x23.50x0.47	33,3	-	12 = 0,36 m ²	108	1.296	38,9	26,5	1.058
216XV - 216ZV	97x597x12	3.82x23.50x0.47	16,7	-	6 = 0,36 m ²	108	648	38,8	27,2	1.080
216XV - 216ZV	147x597x12	5.79x23.50x0.47	11,1	-	8 = 0,721 m ²	56	448	40,4	27,0	1.115











- 216XV560 (5x60 cm) € AP07
 216YV560
 216ZV560
 216XV1060 (10x60 cm) € AP07
 216YV1060
 216ZV1060
 216XV1560 (15x60 cm) € AP07
 216YV1560
 216ZV1560

 anthracite
 316SP, BP, 116VM, 116HM, TVG, HV
 
    R10 C2C 12



- 266XV560 (5x60 cm) € AP07
 266YV560
 266ZV560
 266XV1060 (10x60 cm) € AP07
 266YV1060
 266ZV1060
 266XV1560 (15x60 cm) € AP07
 266YV1560
 266ZV1560

 light beige
 BP, 166VM, 166HM
 
    R10 C2C 49

Elke kleurgroep telt lichte (X), midden (Y) en donkere (Z) tonen. Per kleurgroep worden, per formaat, willekeurige hoeveelheden van X, Y en Z geleverd.
 Chaque groupe de couleur compte des tons clairs (X), moyens (Y) et foncés (Z). Les quantités aléatoires de X, Y et Z sont fournies par format et par groupe de couleur.
 Jede Farbgruppe enthält helle (X), mittlere (Y) und dunkle (Z) Töne. Pro Farbgruppe sind pro Format zufälligen Mengen von X, Y und Z erhältlich.
 Each colour group has light (X), medium (Y), and dark (Z) shades. For each colour group and size, random quantities of X, Y, and Z are supplied.

Voor uitgebreide verwerkingsadviezen zie www.mosa.com.
 On peut trouver toutes les directives de pose sur www.mosa.com.
 Für komplette Hinweise zur Verarbeitung siehe www.mosa.com.
 The complete guidelines for installation can be found on www.mosa.com.

5 x 60 cm / 2 x 24 inch

10 x 60 cm / 4 x 24 inch

15 x 60 cm / 6 x 24 inch

Core Collection Quartz

vloertegels / carreaux de sol / Bodenfliesen / floor tiles
 Ultragres ongeglazuurd / non émaillé / unglasiert / unglazed
 vorstbestand / ingélif / frostsicher / frost proof

reliëftegels / carreaux en relief / Relieffliesen / relief tiles



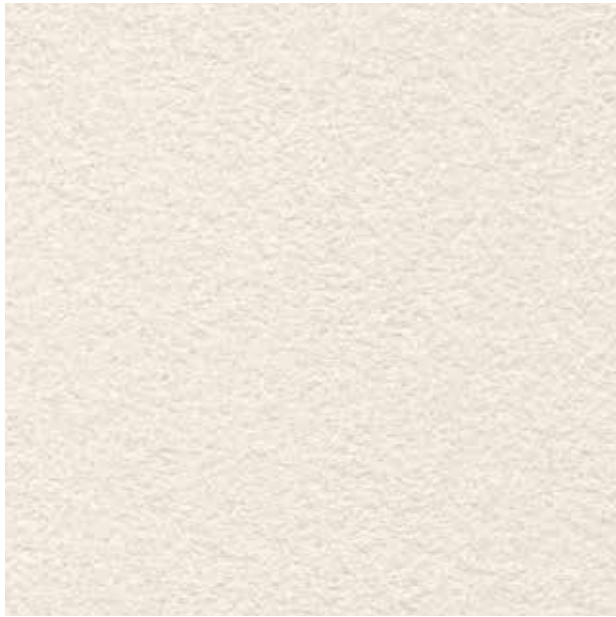

no.	mm	inch	pieces/ m ²	pieces/ m ¹	pieces/ box	boxes/ pallet	pieces/ pallet	m ² / pallet	kg/ m ²	kg/ pallet
4101RQ - 4104RQ	597x597x12	23.50x23.50x0.47	2,8	-	3 = 1,071 m ²	30	90	32,1	27,8	918



4101RQ6060 

 chalk white

 BP

    63

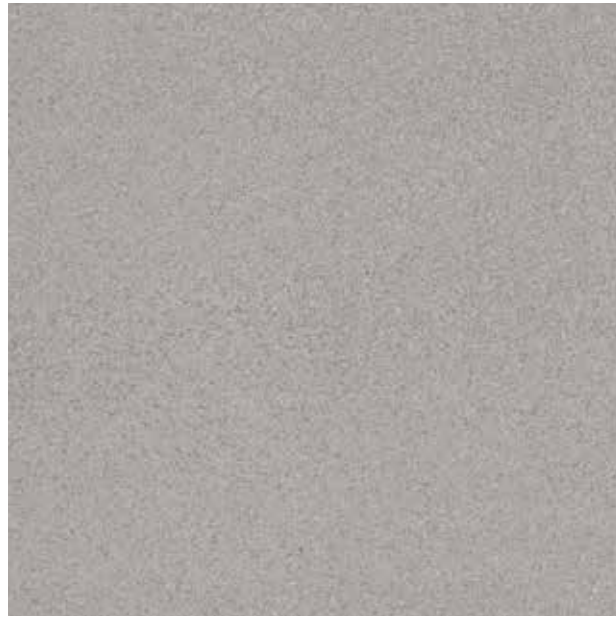

4102RQ6060 

 slate grey

 BP

    39

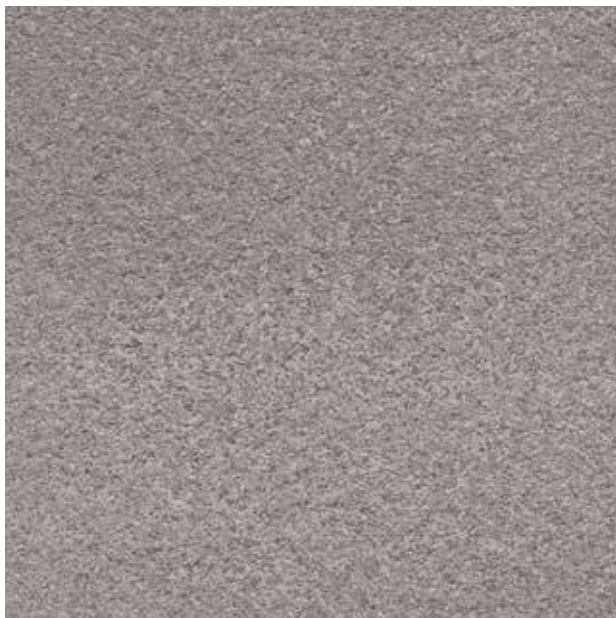

4103RQ6060 

 basalt grey

 BP

    21

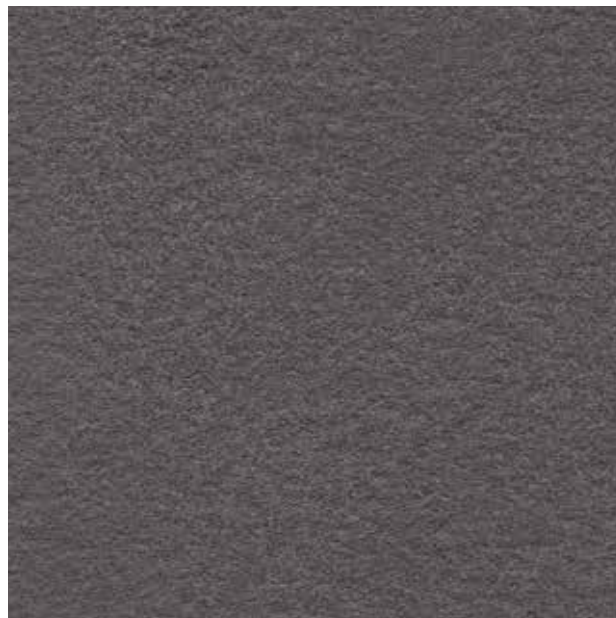

4104RQ6060 

 anthracite black

 BP

    10



Core Collection Quartz

vloertegels / carreaux de sol / Bodenfliesen / floor tiles
 Ultragres ongeglazuurd / non émaillé / unglasiert / unglazed
 vorstbestand / ingélif / frostsicher / frost proof

reliëftegels / carreaux en relief / Relieffliesen / relief tiles

no.	mm	inch	pieces/ m ²	pieces/ m ¹	pieces/ box	boxes/ pallet	pieces/ pallet	m ² / pallet	kg/ m ²	kg/ pallet
4105RQ - 4107RQ	597x597x12	23.50x23.50x0.47	2,8	-	3 = 1,071 m ²	30	90	32,1	27,8	918



4105RQ6060  AP10

 sand beige
 BP
    53



4107RQ6060  AP10

 agate grey
 BP
    20

Core Collection Solids

vloertegels / carreaux de sol / Bodenfliesen / floor tiles
 Ultragres ongeglazuurd / non émaillé / unglasiert / unglazed
 vorstbestand / ingélif / frostsicher / frost proof

reliëftegels / carreaux en relief / Relieffliesen / relief tiles

no.	mm	inch	pieces/ m ²	pieces/ m ¹	pieces/ box	boxes/ pallet	pieces/ pallet	m ² / pallet	kg/ m ²	kg/ pallet
5102MR - 5110MR	597x597x12	23.50x23.50x0.47	2,8	-	3 = 1,071 m ²	30	90	32,1	27,8	918





5102MR6060 

 vivid white

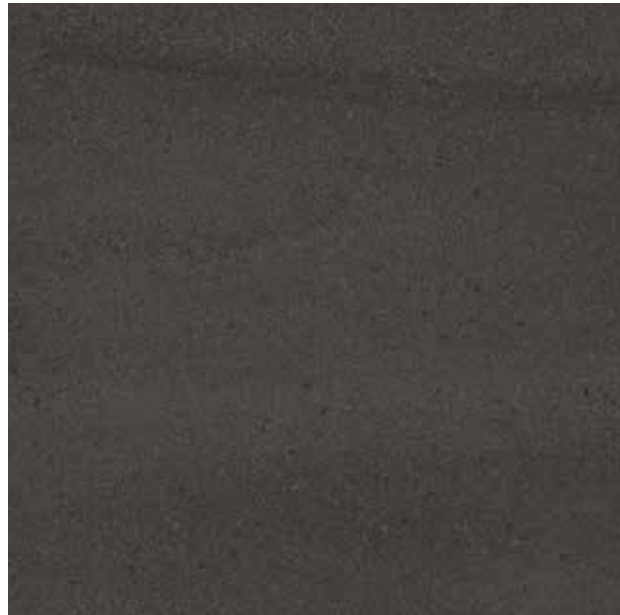





5106MR6060 

 agate grey



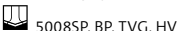

5108MR6060 

 stone grey





5110MR6060 

 basalt grey





Core Collection Solids

vloertegels / carreaux de sol / Bodenfliesen / floor tiles
 Ultragres ongeglazuurd / non émaillé / unglasiert / unglazed
 vorstbestand / ingélif / frostsicher / frost proof

reliëftegels / carreaux en relief / Relieffliesen / relief tiles





no.	mm	inch	pieces/ m ²	pieces/ m ¹	pieces/ box	boxes/ pallet	pieces/ pallet	m ² / pallet	kg/ m ²	kg/ pallet
5120MR	597x597x12	23.50x23.50x0.47	2,8	-	3 = 1,071 m ²	30	90	32,1	27,8	918



5120MR6060  BP03

 jade grey

 5020SP, BP, TVG, HV

  R10  B  C2C  25

Core Collection Terra

vloertegels / carreaux de sol / Bodenfliesen / floor tiles
 Ultragres ongeglazuurd / non émaillé / unglasiert / unglazed
 vorstbestand / ingélif / frostsicher / frost proof

reliëftegels / carreaux en relief / Relieffliesen / relief tiles

no.	mm	inch	pieces/ m ²	pieces/ m ¹	pieces/ box	boxes/ pallet	pieces/ pallet	m ² / pallet	kg/ m ²	kg/ pallet
203RM - 266RM	146x146x7,5	5.75x5.75x0.30	44	-	33 = 0,75 m ²	92	3.036	69,0	16,5	1.164







203RM1515  € FH0

M cool black
 BP, 103VM, 103HM, TVG, HV
    9







204RM1515  € FH0

M mid warm grey
 BP, 304SP, BP, 104VM, 104HM, TVG, HV
    23





206RM1515 € FH0

M mid grey
 BP, 306SP, BP, TVG, HV
    36





216RM1515  € FH0

M anthracite
 BP, 316SP, BP, 116VM, 116HM, TVG, HV
    14



225RM1515  € FH0

M light cool grey
 BP, 125VM, 125HM
    41



226RM1515  € FH0

M mid cool grey
 BP, 126VM, 126HM, TVG, HV
    24



264RM1515  € FH0

M grey brown
 BP, 164VM, 164HM
    16

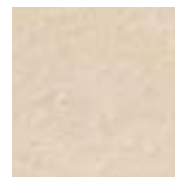

266RM1515  € FH0

M light beige
 BP, 166VM, 166HM
    55



Core Collection Terra

vloertegels / carreaux de sol / Bodenfliesen / floor tiles
 Ultragres ongeglazuurd / non émaillé / unglasiert / unglazed
 vorstbestand / ingélif / frostsicher / frost proof









reliëftegels / carreaux en relief / Relieffliesen / relief tiles

no.	mm	inch	pieces/ m ²	pieces/ m ¹	pieces/ box	boxes/ pallet	pieces/ pallet	m ² / pallet	kg/ m ²	kg/ pallet
203RL - 266RL	296x296x10	11.65x11.65x0.39	11	-	10 = 0,909 m ²	48	480	43,6	23,3	1.043











203RL3030   **BP22**
 cool black
 BP, 103VM, 103HM, TVG, HV
    9











204RL3030   **BP22**
 mid warm grey
 304SP, BP, 104VM, 104HM, TVG, HV
    23



206RL3030   **BP22**
 mid grey
 306SP, BP, TVG, HV
    36





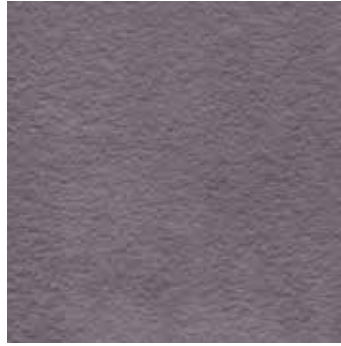





211RL3030   **BP22**
 avalon beige
 BP, TVG, HV
    53



216RL3030   **BP22**
 anthracite
 316SP, BP, 116VM, 116HM, TVG, HV
    14



266RL3030   **BP22**
 light beige
 BP, 166VM, 166HM
    54

Core Collection Terra

vloertegels / carreaux de sol / Bodenfliesen / floor tiles
 Ultragres ongeglazuurd / non émaillé / unglasiert / unglazed
 vorstbestand / ingélif / frostsicher / frost proof

reliëftegels / carreaux en relief / Relieffliesen / relief tiles

no.	mm	inch	pieces/ m ²	pieces/ m ¹	pieces/ box	boxes/ pallet	pieces/ pallet	m ² / pallet	kg/ m ²	kg/ pallet
200RL - 203RL	297x597x12	11.69x23.50x0.47	5,56	-	4 = 0,719 m ²	48	192	34,5	26,5	941
200RL - 203RL	597x597x12	23.50x23.50x0.47	2,8	-	3 = 1,071 m ²	30	90	32,1	27,8	918
200RL - 203RL	47x597x12	1.85x23.50x0.47	33,3	-	24 = 0,721 m ²	56	1.344	40,4	26,5	1.096
200RL - 203RL	97x597x12	3.82x23.50x0.47	16,7	-	12 = 0,721 m ²	56	672	40,4	27,2	1.119
200RL - 203RL	147x597x12	5.79x23.50x0.47	11,1	-	8 = 0,721 m ²	56	448	40,4	27,0	1.115
200RL - 203RL	197x597x12	7.76x23.50x0.47	8,3	-	6 = 0,721 m ²	45	270	32,5	27,7	925

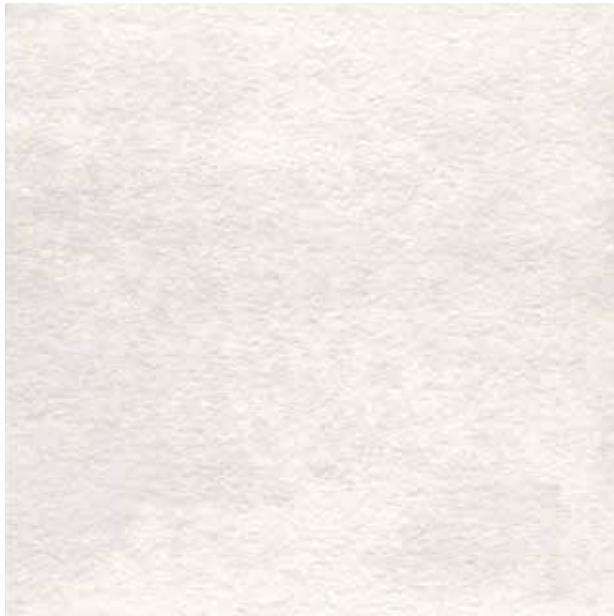

200RL3060		€ BP16
200RL6060		€ BP16
200RL560	(5x60 cm)	€ BP17
200RL1060	(10x60 cm)	€ BP17
200RL1560	(15x60 cm)	€ BP17
200RL2060	(20x60 cm)	€ BP17

 cool porcelain white

 BP, TVG, HV

 R11 C C2C 68

203RL3060		€ BP16
203RL6060		€ BP16
203RL560	(5x60 cm)	€ BP17
203RL1060	(10x60 cm)	€ BP17
203RL1560	(15x60 cm)	€ BP17
203RL2060	(20x60 cm)	€ BP17

 cool black

 BP, 103VM, 103HM, TVG, HV

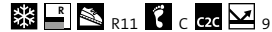
 R11 C C2C 9







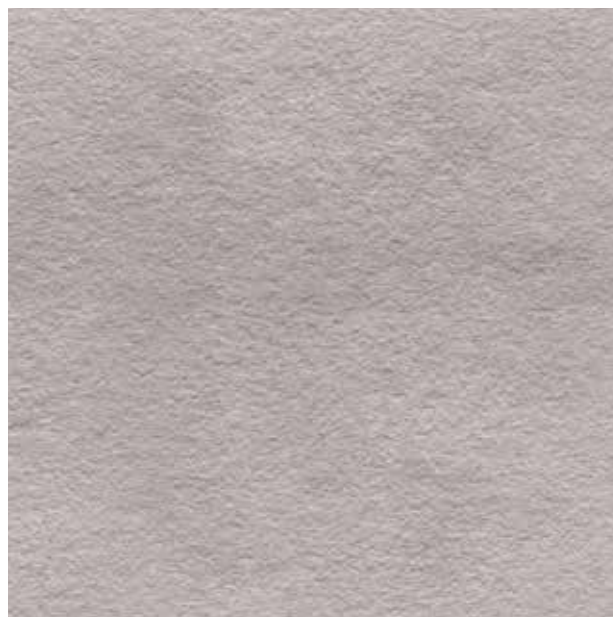

Core Collection Terra

vloertegels / carreaux de sol / Bodenfliesen / floor tiles
 Ultragres ongeglazuurd / non émaillé / unglasiert / unglazed
 vorstbestand / ingélif / frostsicher / frost proof

reliëftegels / carreaux en relief / Relieffliesen / relief tiles

no.	mm	inch	pieces/ m ²	pieces/ m ¹	pieces/ box	boxes/ pallet	pieces/ pallet	m ² / pallet	kg/ m ²	kg/ pallet
204RL - 206RL	297x597x12	11.69x23.50x0.47	5,56	-	4 = 0,719 m ²	48	192	34,5	26,5	941
204RL - 206RL	597x597x12	23.50x23.50x0.47	2,8	-	3 = 1,071 m ²	30	90	32,1	27,8	918
204RL - 206RL	47x597x12	1.85x23.50x0.47	33,3	-	24 = 0,721 m ²	56	1.344	40,4	26,5	1.096
204RL - 206RL	97x597x12	3.82x23.50x0.47	16,7	-	12 = 0,721 m ²	56	672	40,4	27,2	1.119
204RL - 206RL	147x597x12	5.79x23.50x0.47	11,1	-	8 = 0,721 m ²	56	448	40,4	27,0	1.115
204RL - 206RL	197x597x12	7.76x23.50x0.47	8,3	-	6 = 0,721 m ²	45	270	32,5	27,7	925









204RL3060		 BP16
204RL6060		 BP16
204RL560	(5x60 cm)	 BP17
204RL1060	(10x60 cm)	 BP17
204RL1560	(15x60 cm)	 BP17
204RL2060	(20x60 cm)	 BP17

 mid warm grey

 304SP, BP, 104VM, 104HM, TVG, HV

   R11    23

206RL3060		 BP16
206RL6060		 BP16
206RL560	(5x60 cm)	 BP17
206RL1060	(10x60 cm)	 BP17
206RL1560	(15x60 cm)	 BP17
206RL2060	(20x60 cm)	 BP17

 mid grey

 306SP, BP, TVG, HV

   R11    36





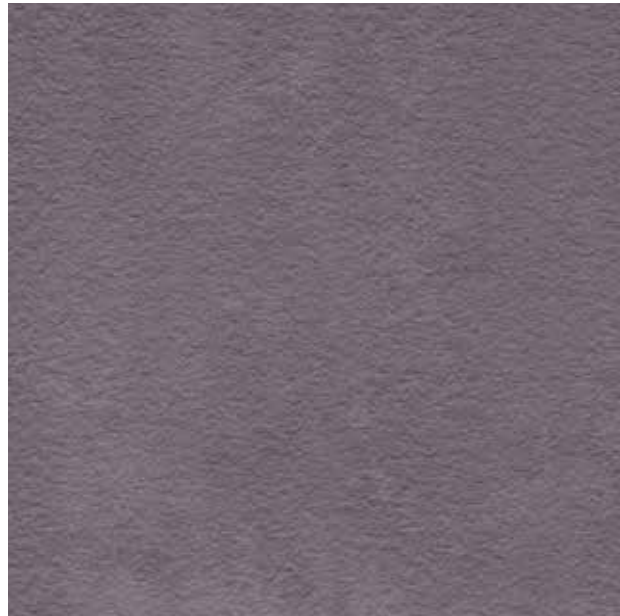

Core Collection Terra

vloertegels / carreaux de sol / Bodenfliesen / floor tiles
 Ultragres ongeglazuurd / non émaillé / unglasiert / unglazed
 vorstbestand / ingélif / frostsicher / frost proof

reliëftegels / carreaux en relief / Relieffliesen / relief tiles

no.	mm	inch	pieces/ m ²	pieces/ m ¹	pieces/ box	boxes/ pallet	pieces/ pallet	m ² / pallet	kg/ m ²	kg/ pallet
211RL - 216RL	297x597x12	11.69x23.50x0.47	5,56	-	4 = 0,719 m ²	48	192	34,5	26,5	941
211RL - 216RL	597x597x12	23.50x23.50x0.47	2,8	-	3 = 1,071 m ²	30	90	32,1	27,8	918
211RL - 216RL	47x597x12	1.85x23.50x0.47	33,3	-	24 = 0,721 m ²	56	1.344	40,4	26,5	1.096
211RL - 216RL	97x597x12	3.82x23.50x0.47	16,7	-	12 = 0,721 m ²	56	672	40,4	27,2	1.119
211RL - 216RL	147x597x12	5.79x23.50x0.47	11,1	-	8 = 0,721 m ²	56	448	40,4	27,0	1.115
211RL - 216RL	197x597x12	7.76x23.50x0.47	8,3	-	6 = 0,721 m ²	45	270	32,5	27,7	925









211RL3060		 BP16
211RL6060		 BP16
211RL560	(5x60 cm)	 BP17
211RL1060	(10x60 cm)	 BP17
211RL1560	(15x60 cm)	 BP17
211RL2060	(20x60 cm)	 BP17

 avalon beige

 BP, TVG, HV

 R11 C C2C 53

216RL3060		 BP16
216RL6060		 BP16
216RL560	(5x60 cm)	 BP17
216RL1060	(10x60 cm)	 BP17
216RL1560	(15x60 cm)	 BP17
216RL2060	(20x60 cm)	 BP17

 anthracite

 316SP, BP, 116VM, 116HM, TVG, HV

 R11 C C2C 14



Holland 2050

vloertegels / carreaux de sol / Bodenfliesen / floor tiles
 Ultragres ongeglazuurd / non émaillé / unglasiert / unglazed
 vorstbestand / ingélif / frostsicher / frost proof

reliëftegels / carreaux en relief / Relieffliesen / relief tiles

no.	mm	inch	pieces/ m ²	pieces/ m ¹	pieces/ box	boxes/ pallet	pieces/ pallet	m ² / pallet	kg/ m ²	kg/ pallet
80010MR - 80060MR	146x146x7	5.75x5.75x0.28	44	-	33 = 0,75 m ²	92	3.036	69,0	15,3	1.082
80010MR - 80060MR	296x296x8	11.65x11.65x0.31	11	-	13 = 1,182 m ²	48	624	56,7	18,3	1.063

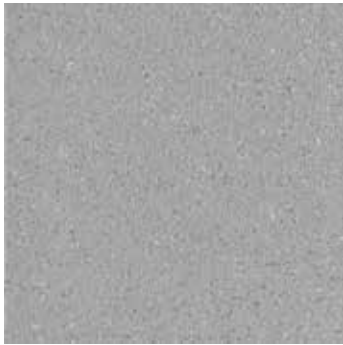

80010MR1515  € FHO
 80010MR3030  € FHO

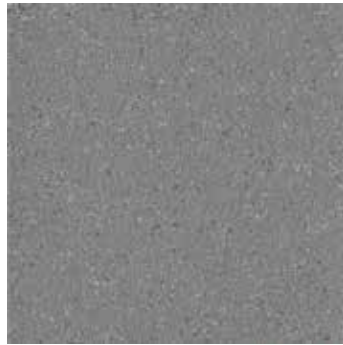

M licht koel grijs / gris frais clair /
 hell kühl grau / light cool grey

 VR, HR, 80011CS1MR, 80011CW1MR  1515
    40



80020MR1515  € FHO
 80020MR3030  € FHO







M donkergrijs / gris foncé /
 dunkelgrau / dark grey

 VR, HR, 80021CS1MR, 80021CW1MR  1515
    25



80030MR1515  € FHO
 80030MR3030  € FHO

M licht antraciet / anthracite clair /
 hell anthrazit / light anthracite

 VR, HR, 80031CS1MR, 80031CW1MR  1515
    13



80040MR1515  € FHO
 80040MR3030  € FHO

M beige / beige /
 beige / beige

 VR, HR  1515
    49



80050MR1515  € FHO
 80050MR3030  € FHO

M midden warm grijs / gris chaleureux moyen /
 mittel warm grau / mid warm grey

 VR, HR, 80051CS1MR, 80051CW1MR  1515
    25



80060MR1515  € FHO
 80060MR3030  € FHO

M grijsbruin / gris-brun /
 graubraun / grey brown

 VR, HR  1515
    16

Scenes



vloertegels / carreaux de sol / Bodenfliesen / floor tiles
 Ultragres ongeglazuurd / non émaillé / unglasiert / unglazed
 vorstbestand / ingélif / frostsicher / frost proof

reliëftegels / carreaux en relief / Relieffliesen / relief tiles

no.	mm	inch	pieces/ m ²	pieces/ m ¹	pieces/ box	boxes/ pallet	pieces/ pallet	m ² / pallet	kg/ m ²	kg/ pallet
6110MR- 6170MR	146x146x7,5	5.75x5.75x0.30	44	-	33 = 0,75 m ²	92	3.036	69,0	16,5	1.164



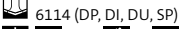

6110MR1515  BP22

 white grey grain
 6114 (DP, DI, DU, SP)
 R10 B C2C 59



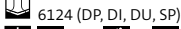

6120MR1515  BP22

 cool grey grain
 6124 (DP, DI, DU, SP)
 R10 B C2C 40



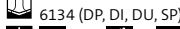

6130MR1515  BP22

 green grey grain
 6134 (DP, DI, DU, SP)
 R10 B C2C 22



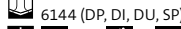

6140MR1515  BP22

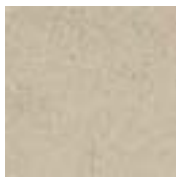
 dark anthracite grain
 6144 (DP, DI, DU, SP)
 R10 B C2C 11



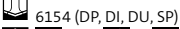

6150MR1515  BP22

 mid beige grain
 6154 (DP, DI, DU, SP)
 R10 B C2C 44



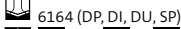

6160MR1515  BP22

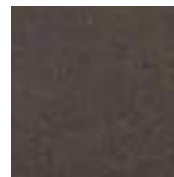
 warm ochre grain
 6164 (DP, DI, DU, SP)
 R10 B C2C 31

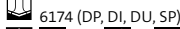

6170MR1515  BP22

 warm grey grain
 6174 (DP, DI, DU, SP)
 R10 B C2C 18



Global Collection

vloertegels / carreaux de sol / Bodenfliesen / floor tiles
 Ultragres ongeglazuurd / non émaillé / unglasiert / unglazed
 vorstbestand / ingélif / frostsicher / frost proof

reliëftegels / carreaux en relief / Relieffliesen / relief tiles

no.	mm	inch	pieces/ m ²	pieces/ m ¹	pieces/ box	boxes/ pallet	pieces/ pallet	m ² / pallet	kg/ m ²	kg/ pallet
750555 - 762755	146x146x7	5.75x5.75x0.28	44	-	33 = 0,75 m ²	92	3.036	69,0	15,3	1.082



75055LS1515 € CP35

M flaked pumice grey
 DP, DI, DU, BN
 R11 B
 c2c 16 NCS S 65005-Y



75075LS1515 € CP35

M flaked bronze yellow
 DP, DI, DU, BN
 R11 B
 c2c 29 NCS S 3020-Y40R

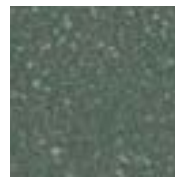

75085LS1515 € CP35

M flaked mineral green
 DP, DI, DU, BN
 R11 B
 c2c 11 NCS S 5010-B90G

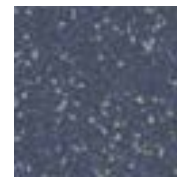

75125LS1515 € CP35

M flaked night blue
 DP, DI, DU, BN
 R11 B
 c2c 9 NCS S 6010-R90B

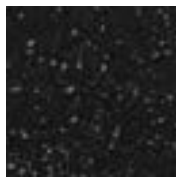

75205LS1515 € CP35

M flaked galactic black
 DP, DI, DU, TS, WS, BN, 75201GL,
 75201GS
 R11 B
 c2c 4 NCS S 7502-B

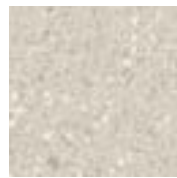

75215LS1515 € CP35

M flaked seashell beige
 DP, DI, DU, BN
 R11 B
 c2c 35 NCS S 3005-Y50R

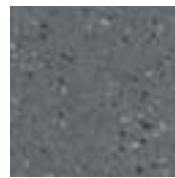

75235LS1515 € CP35

M flaked stone grey
 DP, DI, DU, BN
 R11 B
 c2c 13 NCS S 5502-B



76015LS1515 € CP35

M flaked moonstone white
 DP, DI, DU, BN, 75211GL, 75211GS
 R11 B
 c2c 47 NCS S 1500-N



76265LS1515 € CP35

M flaked maroon red
 DP, DI, DU, BN
 R11 B
 c2c 10 NCS S 6020-Y70R



76275LS1515 € CP35

M flaked glacier grey
 DP, DI, DU, BN, TS, WS
 R11 B
 c2c 34 NCS S 2502-B

Voor tegelpatronen zie generator.mosa.com.
 Pour des motifs de carreaux, visitez generator.mosa.com.
 Für Verlegemuster siehe generator.mosa.com.
 For tile patterns see generator.mosa.com.

Global Collection





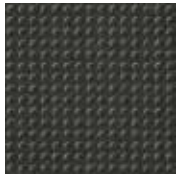

vloertegels / carreaux de sol / Bodenfliesen / floor tiles
 Ultragres ongeglazuurd / non émaillé / unglasiert / unglazed
 vorstbestand / ingélif / frostsicher / frost proof

reliëftegels / carreaux en relief / Relieffliesen / relief tiles

no.	mm	inch	pieces/ m ²	pieces/ m ¹	pieces/ box	boxes/ pallet	pieces/ pallet	m ² / pallet	kg/ m ²	kg/ pallet
75205TS-75275TS	146x146x7,4	5.75x5.75x0.29	44	-	31 = 0,705 m ²	92	2.852	64,8	15,4	1.026
75205WS-76275WS	146x146x7,6	5.75x5.75x0.30	44	-	31 = 0,705 m ²	92	2.852	64,8	15,2	1.009









75205TS1515  CP35

 flaked galactic black
 DP, DI, DU, S, SP
 R11  C
 C2C  4  NCS S 7502-B









76275TS1515  CP35

 flaked glacier grey
 DP, DI, DU, S, SP
 R11  C
 C2C  34  NCS S 2502-B



75205WS1515  CP35

 flaked galactic black
 DP, DI, DU, S, SP
 R12/V4  C
 C2C  4  NCS S 7502-B



76275WS1515  CP35

 flaked glacier grey
 DP, DI, DU, S, SP
 R12/V4  C
 C2C  34  NCS S2502-B





Softgrip

vloertegels / carreaux de sol / Bodenfliesen / floor tiles
 Ultragres ongeglazuurd / non émaillé / unglasiert / unglazed
 vorstbestand / ingélif / frostsicher / frost proof

reliëftegels / carreaux en relief / Relieffliesen / relief tiles



no.	mm	inch	pieces/ m ²	pieces/ m ¹	pieces/ box	boxes/ pallet	pieces/ pallet	m ² / pallet	kg/ m ²	kg/ pallet
74020LS - 74090LS	146x146x7	5.75x5.75x0.28	44	-	33 = 0,75 m ²	92	3.036	69,0	15,3	1.082
74020LS - 74090LS	296x296x8	11.65x11.65x0.31	11	-	13 = 1,182 m ²	48	624	56,7	18,3	1.063







74020LS1515  € FH1
 74020LS3030  € FH1

M grijs / gris /
 grau / grey
 DP, DI, DU, VS, HS
 R11  B
 C2C  38

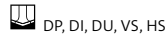





74030LS1515  € FH1
 74030LS3030  € FH1

M muisgrijs / gris de souris /
 mausgrau / mouse grey
 DP, DI, DU, VS, HS
 R11  B
 C2C  24

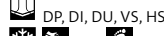





74040LS1515  € FH1

M licht warm grijs /
 gris chaleureux clair /
 hell warm grau / light warm grey
 DP, DI, DU, VS, HS
 R11  B
 C2C  32

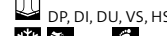





74050LS1515  € FH1

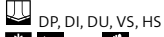

M midden warm grijs /
 gris chaleureux moyen /
 mittel warm grau / mid warm grey
 DP, DI, DU, VS, HS
 R11  B
 C2C  22





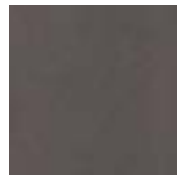

74060LS1515  € FH1

M beige / beige /
 beige / beige
 DP, DI, DU, VS, HS
 R11  B
 C2C  42

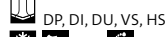

74090LS1515  € FH1
 74090LS3030  € FH1

M ivoorzwart / noir d'ivoire /
 elfenbeinschwarz / ivory black
 DP, DI, DU, VS, HS
 R11  B
 C2C  9



DP, DI, DU Global Collection, Scenes, Softline

vloertegels / carreaux de sol / Bodenfliesen / floor tiles
 Ultragres ongeglazuurd / non émaillé / unglasiert / unglazed
 vorstbestand / ingélif / frostsicher / frost proof

accessoires / accessoires / Formteile / accessories

no.	mm	inch	pieces/ m ²	pieces/ m ¹	pieces/ box	boxes/ pallet	pieces/ pallet	m ² / pallet	kg/ m ²	kg/ pallet
6114DP - 76284DP	75x146x5,5	2.95x5.75x0.22	-	6,67	30 = 4,50 m ¹	192	5.760	-	-	912
6114DI - 76284DU	75x20x5,5	2.95x0.79x0.22	-	-	100	200	20.000	-	-	505

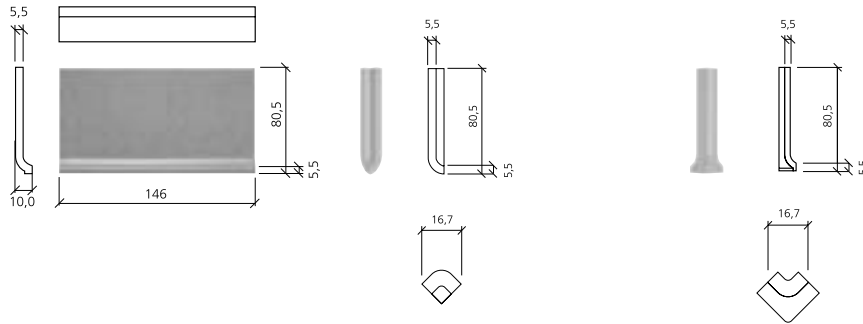

...DP815 € D 38
M dunne holplint /
 plinthe à gorge fine /
 dünner Hohlkehlssockel /
 thin coved skirting (thin cove base)

6114, 6124, 6134, 6144, 6154,
 6164, 6174, 74020, 74030, 74040,
 74050, 74060, 74090, 75050, 75053,
 75054, 75060, 75063, 75064, 75070,
 75073, 75074, 75080, 75083, 75084,
 75100, 75103, 75104, 75110, 75113,
 75114, 75120, 75123, 75124, 75130,
 75133, 75134, 75150, 75153, 75154,
 75180, 75183, 75184, 75200, 75203,
 75204, 75210, 75213, 75214, 75220,
 75223, 75224, 75230, 75233, 75234,
 76010, 76013, 76014, 76240, 76243,
 76244, 76250, 76253, 76254, 76260,
 76263, 76264, 76270, 76273, 76274,
 76280, 76283, 76284



...DI82 € D 59
M inwendig hoekje voor DP /
 angle intérieur pour DP /
 Innenecke für DP /
 internal angle for DP (inside angle)

6114, 6124, 6134, 6144, 6154,
 6164, 6174, 74020, 74030, 74040,
 74050, 74060, 74090, 75050, 75053,
 75054, 75060, 75063, 75064, 75070,
 75073, 75074, 75080, 75083, 75084,
 75100, 75103, 75104, 75110, 75113,
 75114, 75120, 75123, 75124, 75130,
 75133, 75134, 75150, 75153, 75154,
 75180, 75183, 75184, 75200, 75203,
 75204, 75210, 75213, 75214, 75220,
 75223, 75224, 75230, 75233, 75234,
 76010, 76013, 76014, 76240, 76243,
 76244, 76250, 76253, 76254, 76260,
 76263, 76264, 76270, 76273, 76274,
 76280, 76283, 76284



...DU82 € D 59
M uitwendig hoekje voor DP /
 angle extérieur pour DP /
 Außenecke für DP /
 external angle for DP (outside angle)

6114, 6124, 6134, 6144, 6154,
 6164, 6174, 74020, 74030, 74040,
 74050, 74060, 74090, 75050, 75053,
 75054, 75060, 75063, 75064, 75070,
 75073, 75074, 75080, 75083, 75084,
 75100, 75103, 75104, 75110, 75113,
 75114, 75120, 75123, 75124, 75130,
 75133, 75134, 75150, 75153, 75154,
 75180, 75183, 75184, 75200, 75203,
 75204, 75210, 75213, 75214, 75220,
 75223, 75224, 75230, 75233, 75234,
 76010, 76013, 76014, 76240, 76243,
 76244, 76250, 76253, 76254, 76260,
 76263, 76264, 76270, 76273, 76274,
 76280, 76283, 76284



Artikelnummer Numéro d'article Artikelnummer Item number	Bijbehorende dunne holplint Plinthe à gorge fine correspondante Dazu gehörende dünner Hohlkehlssockel Matching thin coved skirting (thin cove base)			
6110V1515	6110MR1515	6111V1515	6112V1515	6114DP815
6120V1515	6120MR1515	6121V1515	6122V1515	6124DP815
6130V1515	6130MR1515	6131V1515	6132V1515	6134DP815
6140V1515	6140MR1515	6141V1515	6142V1515	6144DP815
6150V1515	6150MR1515	6151V1515	6152V1515	6154DP815
6160V1515	6160MR1515	6161V1515	6162V1515	6164DP815
6170V1515	6170MR1515	6171V1515	6172V1515	6174DP815

Accessoire Accessoire Formteil Accessory	In kleur En couleur In der Farbe In colour	Artikelnummer Numéro d'article Artikelnummer Item number
...DP815 +	6114 =	6114DP815

Artikelnummer Numéro d'article Artikelnummer Item number	Bijbehorende plint Plinthe droite correspondante Dazu gehörende Stehssockel Matching skirting
75055S1515	75054DP815
75065S1515	75064DP815
75075S1515	75074DP815
75085S1515	75084DP815
75105S1515	75104DP815
75115S1515	75114DP815
75125S1515	75124DP815
75135S1515	75134DP815
75155S1515	75154DP815
75185S1515	75184DP815
75205S1515	75204DP815
75215S1515	75214DP815
75225S1515	75224DP815
75235S1515	75234DP815
76015S1515	76014DP815
76245S1515	76244DP815
76255S1515	76254DP815
76265S1515	76264DP815
76275S1515	76274DP815
76285S1515	76284DP815

Door de productiewijze kan de maatvoering van deze accessoires enige variatie vertonen.
 En raison de la méthode de production, les dimensions de ces accessoires peuvent présenter des variations.
 Aufgrund des Herstellungsverfahrens dieser Formteile kann eine geringe Abweichung der angestrebten
 Abmessungen nicht ausgeschlossen werden. Due to the production method, the dimensions of these
 accessories may show some variation.



vloertegels / carreaux de sol / Bodenfliesen / floor tiles
 Ultragres ongeglazuurd / non émaillé / unglasiert / unglazed
 vorstbestand / ingélif / frostsicher / frost proof

accessoires / accessoires / Formteile / accessories

no.	mm	inch	pieces/ m ²	pieces/ m ¹	pieces/ box	boxes/ pallet	pieces/ pallet	m ² / pallet	kg/ m ²	kg/ pallet
6114SP - 6174SP	155x146x8	6.10x5.75x0.31	-	6,67	24 = 3,60 m ¹	84	2.016	-	-	848

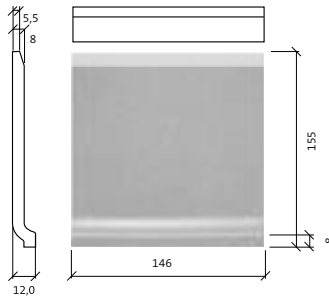

...SP1515  D 50

 holplint /
 plinthe à gorge /
 Hohlkehlsockel /
 coved skirting (cove base)

 6114, 6124, 6134, 6144, 6154,
 6164, 6174

 C2C

Artikelnummer Numéro d'article Artikelnummer Item number	Bijbehorende holplint Plinthe à gorge correspondante Dazu gehörende Hohlkehlsockel Matching coved skirting (cove base)			
6110V1515	6110MR1515	6111V1515	6112V1515	6114SP1515
6120V1515	6120MR1515	6121V1515	6122V1515	6124SP1515
6130V1515	6130MR1515	6131V1515	6132V1515	6134SP1515
6140V1515	6140MR1515	6141V1515	6142V1515	6144SP1515
6150V1515	6150MR1515	6151V1515	6152V1515	6154SP1515
6160V1515	6160MR1515	6161V1515	6162V1515	6164SP1515
6170V1515	6170MR1515	6171V1515	6172V1515	6174SP1515

Accessoire	In kleur	Artikelnummer
Accessoire	En couleur	Numéro d'article
Formteil	In der Farbe	Artikelnummer
Accessory	In colour	Item number
...SP1515	+	6114
	=	6114SP1515



vloertegels / carreaux de sol / Bodenfliesen / floor tiles
 Ultragres ongeglazuurd / non émaillé / unglasiert / unglazed
 vorstbestand / ingélif / frostsicher / frost proof

accessoires / accessoires / Formteile / accessories

no.	mm	inch	pieces/ m ²	pieces/ m ¹	pieces/ box	boxes/ pallet	pieces/ pallet	m ² / pallet	kg/ m ²	kg/ pallet
5002SP - 362SP	146x297x8	5.75x11.69x0.31	-	3,33	12 = 3,60 m ¹	84	1.008	-	-	857

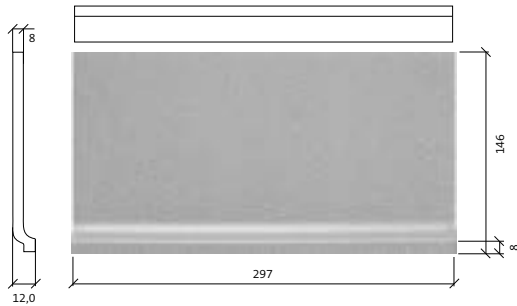

...SP1530

€ D 82

M holplint /
 plinthe à gorge /
 Hohlkehlsocbel /
 coved skirting (cove base)

5002, 5006, 5008, 5010, 5020
 C2C

...SP1530

€ D 76

M holplint /
 plinthe à gorge /
 Hohlkehlsocbel /
 coved skirting (cove base)

304, 306, 315, 316, 362
 C2C

Artikelnummer Numéro d'article Artikelnummer Item number		Bijbehorende holplint Plinthe à gorge correspondante Dazu gehörende Hohlkehlsocbel Matching coved skirting (cove base)
5102V...	5102MR6060	5002SP1530
5106V...	5106MR6060	5006SP1530
5108V...	5108MR6060	5008SP1530
5110V...	5110MR6060	5010SP1530
5120V...	5120MR6060	5020SP1530
204V...		304SP1530
206V...		306SP1530
215V...		315SP1530
216V...		316SP1530
262V...		362SP1530

Accessoire	In kleur	Artikelnummer
Accessoire	En couleur	Numéro d'article
Formteil	In der Farbe	Artikelnummer
Accessory	In colour	Item number
...SP1530	+	5002
	=	5002SP1530





VS, HS, VM, HM, VR, HR

Holland 2050, Softgrip, Core Collection Terra

vloertegels / carreaux de sol / Bodenfliesen / floor tiles
Ultragres ongeglazuurd / non émaillé / unglasiert / unglazed
vorstbestand / ingélif / frostsicher / frost proof

accessoires / accessoires / Formteile / accessories

no.	mm	inch	pieces/ m ²	pieces/ m ¹	pieces/ box	boxes/ pallet	pieces/ pallet	m ² / pallet	kg/ m ²	kg/ pallet
74020VS - 74090VS	146x146x8(-16)	5.75x5.75x0.31(-0.63)	-	6,67	21 = 3,15 m ¹	80	1.680	-	-	910
74020HS - 74090HS	146x146x8(-16)	5.75x5.75x0.31(-0.63)	-	-	16	80	1.280	-	-	729

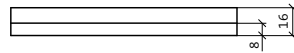
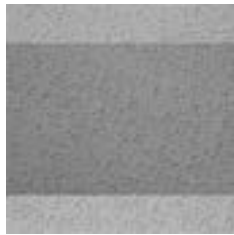

...VS1515



€ D 92

M douchebakplint /
pièce courante /
Gefälleformstück /
sloping shower edge tile

74020, 74030, 74040, 74050,
74060, 74090

R11 B c2c

reliéftegels / carreaux en relief /
Relieffliesen / relief tiles

...HS1515



€ D 92

M douchebakhoekplint /
angle rentrant /
Eckformstück /
sloping shower corner piece

74020, 74030, 74040, 74050,
74060, 74090

R11 B c2c

reliéftegels / carreaux en relief /
Relieffliesen / relief tiles

Voor uitgebreide verwerkingsadviezen zie
www.mosa.com.
On peut trouver toutes les directives de pose sur
www.mosa.com.
Für komplette Hinweise zur Verarbeitung siehe
www.mosa.com.
The complete guidelines for installation can be
found on www.mosa.com.

Accessoire	In kleur	Artikelnummer
Accessoire	En couleur	Numéro d'article
Formteil	In der Farbe	Artikelnummer
Accessory	In colour	Item number
...VS1515	+	74020
	=	74020VS1515



VS, HS, VM, HM, VR, HR

Holland 2050, Softgrip, Core Collection Terra

vloertegels / carreaux de sol / Bodenfliesen / floor tiles
 Ultragres ongeglazuurd / non émaillé / unglasiert / unglazed
 vorstbestand / ingélf / frostsicher / frost proof

accessoires / accessoires / Formteile / accessories

no.	mm	inch	pieces/ m ²	pieces/ m ¹	pieces/ box	boxes/ pallet	pieces/ pallet	m ² / pallet	kg/ m ²	kg/ pallet
103VM - 166VM	146x146x8(-16)	5.75x5.75x0.31(-0.63)	-	6,67	21 = 3,15 m ¹	80	1.680	-	-	910
103HM - 166HM	146x146x8(-16)	5.75x5.75x0.31(-0.63)	-	-	16	80	1.280	-	-	729
80010VR - 80060VR	146x146x8(-16)	5.75x5.75x0.31(-0.63)	-	6,67	21 = 3,15 m ¹	80	1.680	-	-	910
80010HR - 80060HR	146x146x8(-16)	5.75x5.75x0.31(-0.63)	-	-	16	80	1.280	-	-	729

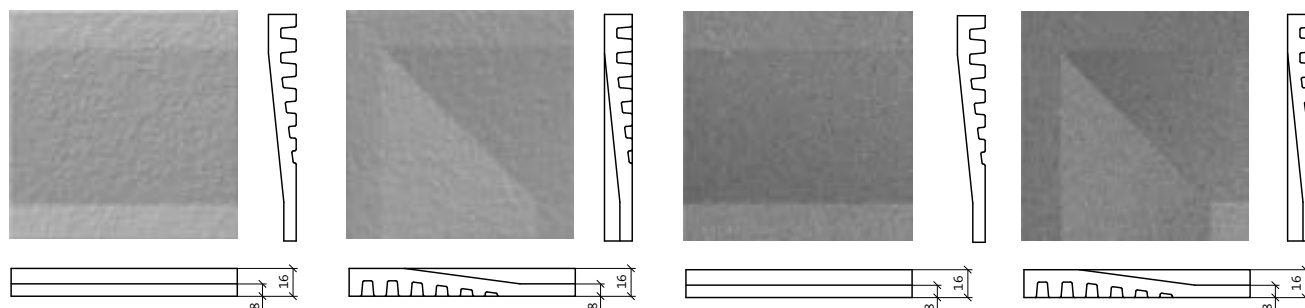

...VM1515 € D 92

M douchebakplint /
 pièce courante /
 Gefälleformstück /
 sloping shower edge tile

103, 104, 116, 125, 126,
 164, 166

reliéftegels / carreaux en relief /
 Relieffliesen / relief tiles

...HM1515 € D 92

M douchebakhoekplint /
 angle rentrant /
 Eckformstück /
 sloping shower corner piece

103, 104, 116, 125, 126,
 164, 166

reliéftegels / carreaux en relief /
 Relieffliesen / relief tiles

...VR1515 € D 92

M douchebakplint /
 pièce courante /
 Gefälleformstück /
 sloping shower edge tile

80010, 80020, 80030, 80040, 80050,
 80060

reliéftegels / carreaux en relief /
 Relieffliesen / relief tiles

...HR1515 € D 92

M douchebakhoekplint /
 angle rentrant /
 Eckformstück /
 sloping shower corner piece

80010, 80020, 80030, 80040, 80050,
 80060

reliéftegels / carreaux en relief /
 Relieffliesen / relief tiles

Artikelnummer Numéro d'article Artikelnummer Item number	Bijbehorende douchebakplint Pièce courante correspondante Dazu gehörend Gefälleformstück Matching sloping shower edge tile	Bijbehorende douchebakhoekplint Angle rentrant correspondant Dazu gehörend Eckformstück Matching sloping shower corner piece
203RM1515	103VM1515	103HM1515
204RM1515	104VM1515	104HM1515
216RM1515	116VM1515	116HM1515
225RM1515	125VM1515	125HM1515
226RM1515	126VM1515	126HM1515
264RM1515	164VM1515	164HM1515
266RM1515	166VM1515	166HM1515

Voor uitgebreide verwerkingsadviezen zie www.mosa.com.
 On peut trouver toutes les directives de pose sur www.mosa.com.
 Für komplette Hinweise zur Verarbeitung siehe www.mosa.com.
 The complete guidelines for installation can be found on www.mosa.com.

Accessoire Accessoire Formteil Accessory	In kleur En couleur In der Farbe In colour	Artikelnummer Numéro d'article Artikelnummer Item number
...VM1515 +	103 =	103VM1515



vloertegels / carreaux de sol / Bodenfliesen / floor tiles
 Ultragres ongeglazuurd / non émaillé / unglasiert / unglazed
 vorstbestand / ingélif / frostsicher / frost proof

accessoires / accessoires / Formteile / accessories

no.	mm	inch	pieces/ m ²	pieces/ m ¹	pieces/ box	boxes/ pallet	pieces/ pallet	m ² / pallet	kg/ m ²	kg/ pallet
75201GL - 75211GL	296x296x12,5	11.65x11.65x0.49	-	3,33	9 = 2,70 m ¹	44	396	-	-	895
75201GS - 75211GS	296x296x14,5	11.65x11.65x0.57	-	3,33	9 = 2,70 m ¹	44	396	-	-	895

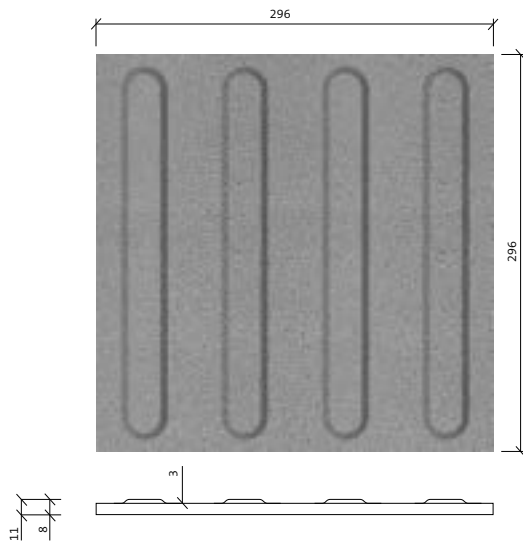

...GL3030 D 248

guideline /
 guideline /
 guideline /
 guideline

75201, 75211

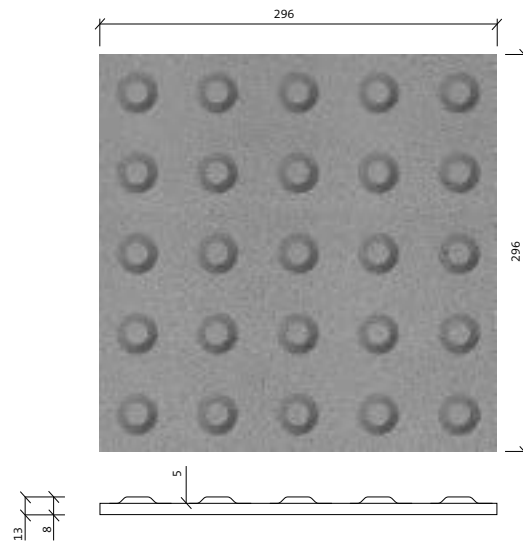

...GS3030 D 248

guidestop /
 guidestop /
 guidestop /
 guidestop

75201, 75211

Artikelnummer Numéro d'article Artikelnummer Item number	Bijbehorende guideline Guideline correspondant Dazu gehörende guideline Matching guideline	Bijbehorende guidestop Guidestop correspondant Dazu gehörende guidestop Matching guidestop
75200V....	75201GL3030	75201GS3030
75210V....	75211GL3030	75211GS3030

Accessoire Accessoire Formteil Accessory	In kleur En couleur In der Farbe In colour	Artikelnummer Numéro d'article Artikelnummer Item number
...GL3030 +	75201 =	75201GL3030





vloertegels / carreaux de sol / Bodenfliesen / floor tiles
 Ultragres ongeglazuurd / non émaillé / unglasiert / unglazed
 vorstbestand / ingélif / frostsicher / frost proof

accessoires / accessoires / Formteile / accessories

no.	mm	inch	pieces/ m ²	pieces/ m ¹	pieces/ box	boxes/ pallet	pieces/ pallet	m ² / pallet	kg/ m ²	kg/ pallet
75055BN - 76285BN	296x70x8	11.65x2.76x0.31	-	3,33	25 = 7,51 m ¹	108	2.700	-	-	1.059

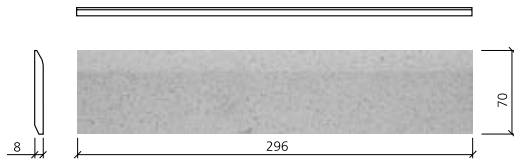

...BN307 D 39

M plint /
 plinthe droite /
 Stehsockel /
 skirting (bullnose)

75055, 75065, 75075, 75085,
 75105, 75115, 75125, 75135,
 75155, 75185, 75205, 75215,
 75225, 75235, 76015, 76245,
 76255, 76265, 76275, 76285

Artikelnummer Numéro d'article Artikelnummer Item number	Bijbehorende plint Plinthe droite correspondante Dazu gehörende Stehsockel Matching skirting
75055S	75055BN307
75065S	75065BN307
75075S	75075BN307
75085S	75085BN307
75105S	75105BN307
75115S	75115BN307
75125S	75125BN307
75135S	75135BN307
75155S	75155BN307
75185S	75185BN307
75205S	75205BN307
75215S	75215BN307
75225S	75225BN307
75235S	75235BN307
76015S	76015BN307
76245S	76245BN307
76255S	76255BN307
76265S	76265BN307
76275S	76275BN307
76285S	76285BN307





BP Core Collection Quartz, Core Collection Solids, Core Collection Terra, Mosa Stage

vloertegels / carreaux de sol / Bodenfliesen / floor tiles
 Ultragres ongeglazuurd / non émaillé / unglasiert / unglazed
 vorstbestand / ingélf / frostsicher / frost proof

accessoires / accessoires / Formteile / accessories

no.	mm	inch	pieces/ m ²	pieces/ m ¹	pieces/ box	boxes/ pallet	pieces/ pallet	m ² / pallet	kg/ m ²	kg/ pallet
203BP - 266BP	296x95x10	11.65x3.74x0.39	-	3,33	21 = 6,31 m ¹	66	1.386	-	-	934
200BP - 5126BP	597x95x12	23.50x3.74x0.47	-	1,67	12 = 7,19 m ¹	56	672	-	-	1.071
200BP - 5112BP	897x95x13	35.31x3.74x0.51	-	1,11	6 = 5,41 m ¹	48	288	-	-	746

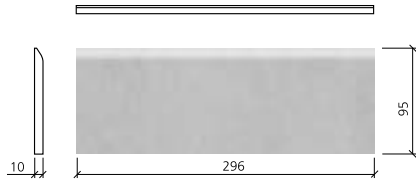

...BP3010 € D 69

M plint / plinthe droite /
 Stehsockel / skirting (bullnose)

❄ 203, 204, 206, 211, 216,
 225, 226, 227, 229, 264,
 266

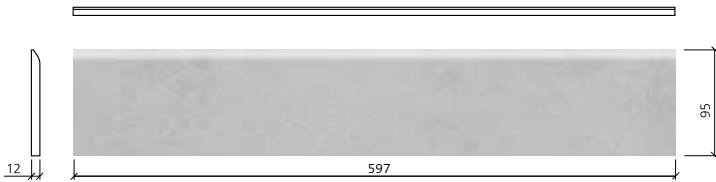

...BP6010 € D 117

M plint / plinthe droite /
 Stehsockel / skirting (bullnose)

❄ 200, 203, 204, 206, 211,
 214, 215, 216, 222, 225,
 226, 227, 229, 238, 239,
 262, 263, 264, 265, 266,
 270, 3502, 3504, 3506, 3508,
 3510, 3512, 3514, 3516, 3518,
 4101, 4102, 4103, 4104, 4105,
 4107, 5102, 5104, 5106, 5108,
 5110, 5112, 5118, 5120, 5126

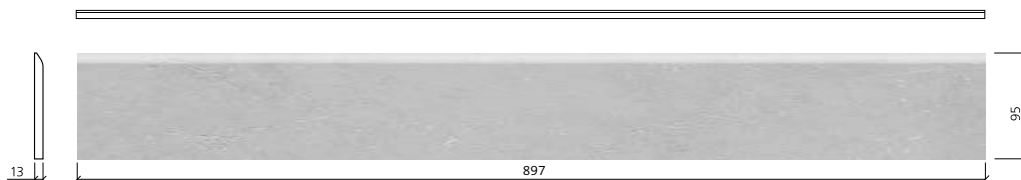

...BP9010 € D 249

M plint / plinthe droite /
 Stehsockel / skirting (bullnose)

❄ 200, 203, 204, 206, 211,
 216, 225, 226, 227, 229,
 262, 3502, 3504, 3506, 3508,
 3510, 3512, 3514, 3516, 3518,
 5102, 5104, 5106, 5108, 5110,
 5112

Accessoire	In kleur	Artikelnummer
Accessoire	En couleur	Numéro d'article
Formteil	In der Farbe	Artikelnummer
Accessory	In colour	Item number
...BP3010	+	203
	=	203BP3010

vloertegels / carreaux de sol / Bodenfliesen / floor tiles
 Ultragres ongeglazuurd / non émaillé / unglasiert / unglazed
 vorstbestand / ingélif / frostsicher / frost proof

accessoires / accessoires / Formteile / accessories

no.	mm	inch	pieces/ m ²	pieces/ m ¹	pieces/ box	boxes/ pallet	pieces/ pallet	m ² / pallet	kg/ m ²	kg/ pallet
5102TVG - 5126TVG	297x597x12	11.69x23.50x0.47	-	1,67	4 = 2,40 m ¹	48	192	-	-	941
200TVG - 265TVG	297x1197x13	11.69x47.13x0.51	-	0,83	2 = 2,41 m ¹	42	84	-	-	922

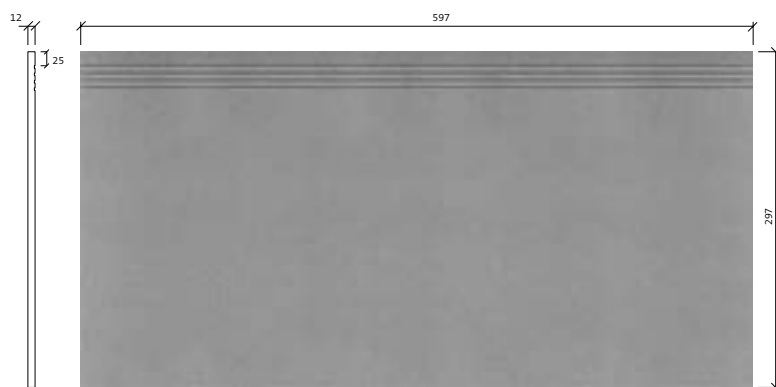

...TVG3060  D 289

M traptegel (rechte, geglazuurde voorzijde) /
 nez de marche (bord droit, côté émaillé) /
 Treppenfliese (eckige, überglaste Kante) /
 stair tread (straight, glazed edge)

 5102, 5104, 5106, 5108, 5110,
 5112, 5118, 5120, 5126

 R10

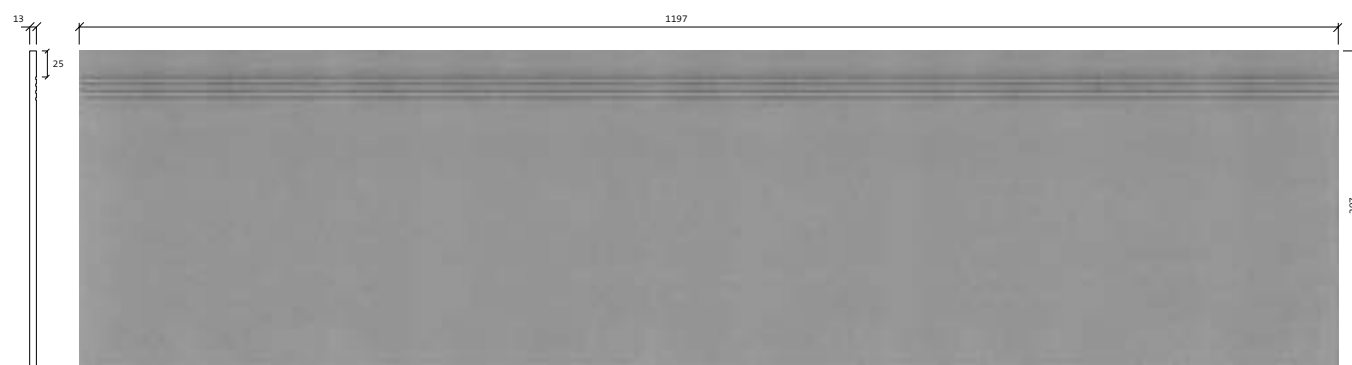

...TVG30120  D 380

M traptegel (rechte, geglazuurde voorzijde) /
 nez de marche (bord droit, côté émaillé) /
 Treppenfliese (eckige, überglaste Kante) /
 stair tread (straight, glazed edge)

 200, 203, 204, 206, 211,
 216, 226, 227, 229, 262,
 265

 R10

Accessoire	In kleur	Artikelnummer
Accessoire	En couleur	Numéro d'article
Formteil	In der Farbe	Artikelnummer
Accessory	In colour	Item number
...TVG3060	+	5102
	=	5102TVG3060



vloertegels / carreaux de sol / Bodenfliesen / floor tiles
 Ultragres ongeglazuurd / non émaillé / unglasiert / unglazed
 vorstbestand / ingélif / frostsicher / frost proof

accessoires / accessoires / Formteile / accessories

no.	mm	inch	pieces/ m ²	pieces/ m ¹	pieces/ box	boxes/ pallet	pieces/ pallet	m ² / pallet	kg/ m ²	kg/ pallet
3502TCG - 3518TCG	297x597x12	11.69x23.50x0.47	-	1,67	4 = 2,40 m ¹	48	192	-	-	941

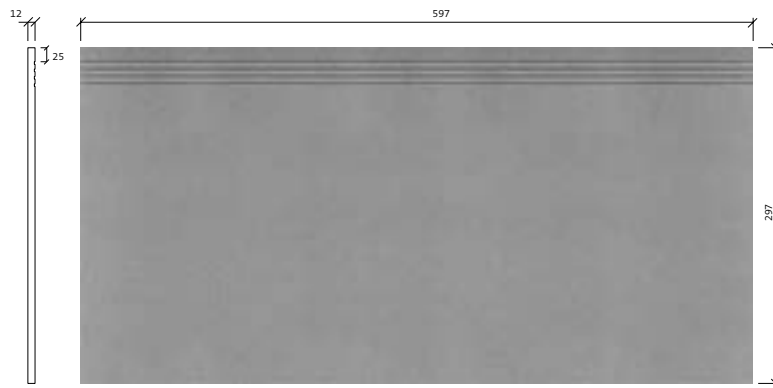

...TCG3060

€ D 289

M traptegel (rechte, geglazuurde voorzijde) /
 nez de marche (bord droit, côté émaillé) /
 Treppenfliese (eckige, überglasierte Kante) /
 stair tread (straight, glazed edge)

3502, 3504, 3506, 3508, 3510,
 3512, 3514, 3516, 3518

R10 B

Accessoire	In kleur	Artikelnummer
Accessoire	En couleur	Numéro d'article
Formteil	In der Farbe	Artikelnummer
Accessory	In colour	Item number
...TCG3060	+ 3502	= 3502TCG3060

vloertegels / carreaux de sol / Bodenfliesen / floor tiles
 Ultragres ongeglazuurd / non émaillé / unglasiert / unglazed
 vorstbestand / ingélif / frostsicher / frost proof

accessoires / accessoires / Formteile / accessories

no.	mm	inch	pieces/ m ²	pieces/ m ¹	pieces/ box	boxes/ pallet	pieces/ pallet	m ² / pallet	kg/ m ²	kg/ pallet
75053TSG - 76285TSG	296x296x8	11.65x11.65x0.31	11	-	13	48	624	-	-	1058

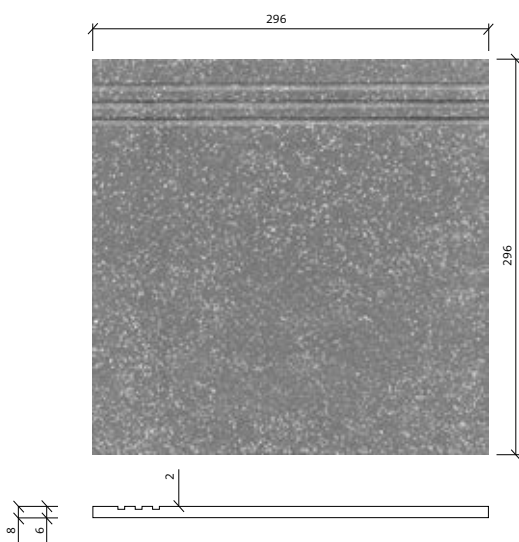

...TSG3030

€ D 280

M traptegel (rechte, geglazuurde voorzijde) /
 nez de marche (bord droit, côté émaillé) /
 Treppenfliese (eckige, überglasierte Kante) /
 stair tread (straight, glazed edge)

 75053, 75063, 75073, 75083, 75103,
 75113, 75123, 75133, 75153, 75183,
 75203, 75213, 75223, 75233, 76013,
 76243, 76253, 76263, 76273, 76283,
 75055, 75065, 75075, 75085, 75105,
 75115, 75125, 75135, 75155, 75185,
 75205, 75215, 75225, 75235, 76015,
 76245, 76255, 76265, 76275, 76285

  R10 B

 C2C

Accessoire	In kleur	Artikelnummer
Accessoire	En couleur	Numéro d'article
Formteil	In der Farbe	Artikelnummer
Accessory	In colour	Item number
...TSG3030	+	75053
	=	75053TSG3030





HV Core Collection Solids, Core Collection Terra

vloertegels / carreaux de sol / Bodenfliesen / floor tiles
 Ultragres ongeglazuurd / non émaillé / unglasiert / unglazed
 vorstbestand / ingélif / frostsicher / frost proof

accessoires / accessoires / Formteile / accessories

no.	mm	inch	pieces/ m ²	pieces/ m ¹	pieces/ box	boxes/ pallet	pieces/ pallet	m ² / pallet	kg/ m ²	kg/ pallet
5102HV - 5126HV	297x597x12	11.69x23.50x0.47	-	1,67	2 = 1,20 m ¹	24	48	-	-	306
200HV - 262HV	297x1197x13	11.69x47.13x0.51	-	0,83	2 = 2,41 m ¹	22	44	-	-	541

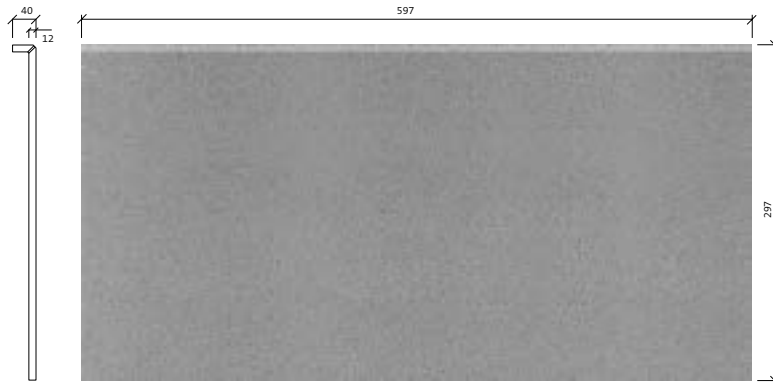

...HV3060 € D 641

M traptegel (met hoek) /
 nez de marche (avec coin) /
 Treppenfliese (mit Ecke) /
 stair tread (with corner)

5102, 5104, 5106, 5108, 5110,
 5112, 5118, 5120, 5126
 R10



...HV30120 € D 676

M traptegel (met hoek) /
 nez de marche (avec coin) /
 Treppenfliese (mit Ecke) /
 stair tread (with corner)

200, 203, 204, 206, 211,
 216, 226, 227, 229, 262
 R10

Accessoire	In kleur	Artikelnummer
Accessoire	En couleur	Numéro d'article
Formteil	In der Farbe	Artikelnummer
Accessory	In colour	Item number
...HV3060	+	5102
	=	5102HV3060

Mosa.

General Conditions

Algemene verkoop-, leverings- en betalingsvoorwaarden van Koninklijke Mosa bv

1. Toepasselijkheid van deze voorwaarden

- 1.1 Deze voorwaarden zijn van toepassing op alle door Koninklijke Mosa, verder te noemen: "Mosa" gedane aanbiedingen, leveringen en overeenkomsten waarbij Mosa partij is, tenzij partijen schriftelijk uitdrukkelijk anders overeengekomen zijn.
- 1.2 Eventuele (inkoop)voorwaarden van de partij waarmee Mosa een overeenkomst sluit, verder te noemen: "contractant" zijn niet van toepassing ook als daarnaar door de contractant in van haar afkomstige correspondentie en stukken, uitdrukkelijk is naar verwezen.
- 1.3 Deze Algemene voorwaarden zijn gedeponereerd bij de Kamer van Koophandel en Fabrieken voor Zuid-Limburg te Maastricht, Nederland, onder nummer 14600086.

2. Aanbiedingen en prijzen

- 2.1 Een order verstrekt door de contractant, is voor hem bindend, ongeacht de wijze waarop deze door hem is gegeven. Dit geldt ook indien de order is verstrekt door agenten, vertegenwoordigers of andere tussenpersonen, waarbij bij wege van vaststelling geldt dat het bewijs dat de order niet bindend is ex artikel 7:900 BW rust op de contractant.
- 2.2 Alle aanbiedingen/offertes zijn voor Mosa geheel vrijblijvend. Overeenkomsten komen eerst tot stand wanneer Mosa nadat zij de order heeft ontvangen, deze schriftelijk bevestigt, dan wel met de uitvoering van de order is begonnen.
2.3 Aanbiedingen/offertes zijn gebaseerd op de door de contractant verstrekte gegevens omtrent het door haar voorziene gebruik, haar (bedrijfs)behoeften etc., van de juistheid waarvan Mosa steeds geacht wordt te mogen uitgaan.
- 2.4 Een aanbieding/offerte wordt in elk geval geacht te zijn verworpen indien een daarop gebaseerde order niet binnen 6 weken ondertekend aan Mosa is gestuurd.
- 2.5 Wijzigingen in de order dienen door de contractant schriftelijk aan Mosa te worden medegedeeld. Pas door en vanaf de schriftelijke aanvaarding daarvan door Mosa, zijn wijzigingen in de order van kracht. Eventuele meer- of minderkosten als gevolg van door Mosa aanvaarde wijzigingen in de order komen ten laste c.q. ten gunste van de contractant. Wijzigingen in de order kunnen tot gevolg hebben dat de overeengekomen levertijd wordt overschreden. Mosa is hiervoor op generlei wijze aansprakelijk, onverminderd het bepaalde in artikel 3.3.
- 2.6 Monsters/profexemplaren worden steeds bij wijze van aanduiding verstrekt, zonder dat de zaken daaraan dienen te beantwoorden. Het is niet toegestaan monsters/profexemplaren te verhandelen en/of te ge- of verbruiken.
- 2.7 Alle prijzen zijn exclusief omzetbelasting en zijn FCA (ICC Incoterms 2020) af (opslag)locatie Mosa conform de door Mosa opgestelde prijsvoorwaarden, geldend op de dag van aflevering.
- 2.8 Indien zich gedurende het tijdvak gelegen tussen enerzijds de offertedatum resp. de totstandkoming van de overeenkomst en anderzijds de datum van levering, een stijging van een of meerdere kostprijsfactoren voordoet, is Mosa gerechtigd de prijzen dienovereenkomstig te verhogen, met dien verstande: - dat indien aflevering van de zaken plaatsvindt binnen 30 dagen na totstandkoming van de overeenkomst, de in de overeenkomst vermelde prijzen onveranderd worden aangehouden; - dat indien binnen 3 maanden na het sluiten van de overeenkomst een prijsverhoging plaatsvindt, de contractant gerechtigd is om binnen 8 dagen na verzending van de mededeling daarvan, de overeenkomst voor het nog niet uitgevoerde deel ontbonden te verklaren, hetgeen uitsluitend schriftelijk kan geschieden. De contractant heeft in zodanig geval geen recht op schadevergoeding.
- 2.9 De inhoud van door Mosa geachte folders, haar drukwerken etc. binden haar niet tenzij dit in de overeenkomst uitdrukkelijk is bepaald of hiernaar in de overeenkomst uitdrukkelijk wordt verwezen. In dat laatste geval is Mosa nimmer gebonden aan eventuele druk- en/of zetfouten.

3. Levering

- 3.1 Levering van de zaken door Mosa geschiedt FCA (ICC Incoterms 2020) af (opslag)locatie Mosa. Vanaf het moment van levering zijn de zaken voor rekening en risico van de contractant.
- 3.2 De contractant is gehouden de zaken bij levering te controleren op zichtbare gebreken, alsmede deze te keuren naar maat, tint, soort, type en hoeveelheid, een en ander voorzover van toepassing. Indien de contractant de zaken in ontvangst neemt zonder schriftelijke aan- of opmerkingen, wordt de contractant na 8 dagen geacht de zaken volledig en zonder voorbehoud te hebben geaccepteerd. Reclames ten aanzien van zichtbare gebreken worden in dat geval niet in behandeling genomen en het recht op ontbinding van de overeenkomst, het recht tot het vorderen van nakoming en/of schadevergoeding vervalt.
- 3.3 De opgegeven levertermijnen en -tijden gelden bij benadering, en zijn niet te beschouwen als fatale termijnen. Het niet aanhouden van de door Mosa opgegeven levertijden kan niet aangemerkt worden als een toerekenbare tekortkoming van laattgenomen en geeft de contractant niet het recht de overeenkomst te ontbinden of de opdracht te annuleren en levert evenmin een grond voor schadevergoeding op, dan na ommekeerom een termijn van 3 maanden te rekenen vanaf de overeengekomen levertijd, gevolgd door een bij aangetekend schrijven of per deurwaardersexploot verzonden ingebrekestelling waarbij Mosa een redelijke termijn wordt gegund om de verbintenis tot levering alsnog na te komen, respectievelijk de verstrekte opdracht alsnog uit te voeren. In ieder geval levert het niet inhouden van levertijden nooit een grond voor schadevergoeding op. Indien (tijdelijke) levering op enig moment onmogelijk blijkt te zijn, zal Mosa dat zo spoedig mogelijk kenbaar maken.
- 3.4 De contractant is verplicht de gekochte zaken af te nemen binnen de overeengekomen termijn. Indien hij zulks nalaat staat het Mosa vrij naar eigen inzicht over de zaken te beschikken, onverminderd de verschuldigdheid van de koopsom.
- 3.5 Indien geen termijn van afname is overeengekomen dient de contractant de zaken af te nemen binnen 1 maand na de opgegeven levertijd. Indien de opgegeven levertijd onverhoopt niet gerealiseerd kan worden door Mosa dient de contractant de zaken af te nemen binnen 1 maand na de door Mosa aangepaste levertijd. Indien de contractant zulks nalaat staat het Mosa vrij naar eigen inzicht over de zaken te beschikken, onverminderd de verschuldigdheid van de koopsom.

- 3.6 De contractant zal Mosa tenminste 24 uur voor de afname schriftelijk in kennis stellen wanneer de zaken door hem worden afgehaald. Indien hij zulks nalaat, blijven eventuele hieruit voortvloeiende (meer-)kosten voor zijn rekening.
- 3.7 Indien de contractant wenst dat de zaken door Mosa worden getransporteerd en Mosa stemt hiermee in dan geldt onverminderd dat de zaken FCA (ICC Incoterms 2020) af (opslag)locatie Mosa worden geleverd. De zaken zijn derhalve voor risico van de contractant vanaf het moment van levering FCA (ICC Incoterms 2020) af (opslag)locatie Mosa. Het vervoer geschiedt voorts voor rekening en risico van de contractant. De minimale afroepstermijn voor de contractant bedraagt in dat geval 48 uur.

4. Betaling en zekerheid

- 4.1 De facturering geschiedt tegelijk met de levering. Tenzij anders is overeengekomen, dient de contractant de facturen binnen 30 dagen na de factuurdatum te betalen, zonder dat verrekening, opschorting en of korting is toegestaan. Indien de contractant

binnen 10 dagen na de factuurdatum betaalt, en overigens alle voorgaande facturen tijdig door de contractant zijn voldaan, wordt door Mosa een betalingskorting van 1% verleend.

- 4.2 Indien het factuurbedrag niet op de vervaldag is voldaan, is de contractant in verzuim door het enkele verloop van de termijn, zonder dat enige ingebrekestelling is vereist. In dat geval wordt de vordering van Mosa van rechtswege verhoogd met vertragingsrente ter hoogte van 1,5% per maand (of een gedeelte daarvan) over de factuurwaarde inclusief omzetbelasting, te berekenen vanaf de vervaldag. Indien de wettelijke handelsrente over een bepaalde periode hoger mocht zijn dan voornoemd percentage heeft Mosa het recht de wettelijke handelsrente in rekening te brengen. Indien de contractant in verzuim is, dient hij tevens incassokosten te vergoeden, welke kosten gesteld worden op 15% van het factuurbedrag met een minimum van EUR 115,-.
- 4.3 De door de contractant gedane betalingen strekken steeds ter afdoening in de eerste plaats van alle verschuldigde kosten, in de tweede plaats van alle verschuldigde renten en in de derde plaats van opeisbare facturen die het langst open staan, zelfs al vermeldt de contractant dat de voldoening betrekking heeft op een latere factuur.
- 4.4 Mosa behoudt zich het recht voor om gedurende de uitvoering van de overeenkomst vooruitbetaling te verlangen.
- 4.5 Mosa kan gedurende de uitvoering van de overeenkomst een passende (d.w.z. haar conveniërende) zekerheid verlangen. Op eerste verzoek van Mosa dient de contractant deze zekerheid te verschaffen.
- 4.6 Alle vorderingen van Mosa zijn ineens en adeliijk opeisbaar indien:
a. de contractant niet of niet tijdig betaalt;
b. de contractant geen vooruitbetaling of passende zekerheid verstrekt na een daartoe strekkend verzoek van Mosa als bedoeld in artikel 4.4 en 4.5;
c. het faillissement/schuldsanering van de contractant wordt aangevraagd of een hiermee gelijk te stellen rechtsfiguur in het land van de contractant;
d. op enig onderdeel van de bezittingen of het vermogen van de contractant beslag wordt gelegd of een hiermee gelijk te stellen rechtsfiguur in het land van de contractant;
e. de contractant sursance van betaling aanvraagt/verkiijgt of een hiermee gelijk te stellen rechtsfiguur in het land van de contractant;
f. de contractant zijn bedrijf/onderneming geheel of gedeeltelijk verkooft of beëindigt of een hiermee gelijk te stellen rechtsfiguur in het land van de contractant;
g. de directe of indirecte zeggenschap binnen contractant verandert;
h. de contractant zijn verplichtingen jegens Mosa niet nakomt.

- 4.7 In de gevallen als omschreven in artikel 4.6 heeft Mosa het recht:
a. haar contractuele verplichtingen op te schorten tot het moment waarop de contractant volledig aan zijn verplichtingen heeft voldaan;
b. de overeenkomst geheel of gedeeltelijk te annuleren en/of te ontbinden door middel van een eenvoudige mededeling, zonder dat hiervoor een ingebrekestelling of rechterlijke tussenkomst vereist is; onverminderd het recht van Mosa op nakoming en/of schadevergoeding.
- 4.8 Mosa is gerechtigd haar vorderingen op de contractant te verrekenen met een of meerdere vorderingen van de contractant, die de contractant op enig moment heeft op Mosa dan wel op een of meerdere venootschappen binnen het concern waartoe Mosa behoort.
- 4.9 Indien Mosa met contractant is overeengekomen dat Mosa automatische incasso mag toepassen, is het contractant niet toegestaan om zonder voorafgaande schriftelijke instemming van Mosa het automatisch door Mosa uit hoofde van leveringen aan contractant door Mosa geïncasseerde bedrag te storneren.

5. Eigendomsvoorbehoud

- 5.1 Alle geleverde of nog te leveren zaken blijven uitsluitend eigendom van Mosa, totdat alle vorderingen die Mosa op de contractant heeft of zal verkrijgen, waarover in ieder geval de vorderingen genoemd in artikel 3:92 lid 2 BW, volledig zijn betaald.
- 5.2 Zolang de vorderingen door de contractant niet volledig zijn voldaan, is het de contractant uitdrukkelijk niet toegestaan geleverde zaken - anders dan in het kader van de normale bedrijfsuitoefening - te vervreemden of (te doen) verwerken. Zolang meergenoemde vorderingen niet volledig aan Mosa zijn voldaan, is contractant niet bevoegd geleverde zaken te bezwaren. Contractant garandeert eventuele derden met zekerheids- rechten van dit artikel 5.2 uitdrukkelijk op de hoogte te stellen. De contractant verplicht zich op eerste verzoek van Mosa mee te werken aan vestiging van een pandrecht op de vorderingen die de contractant uit hoofde van doorlevering, in het kader van de normale bedrijfsuitoefening, van zaken op zijn afnemers verkrijgt of zal verkrijgen.
- 5.3 De contractant is verplicht de zaken die onder eigendomsvoorbehoud zijn afgeleverd met de nodige zorgvuldigheid en als herkenbaar eigendom van Mosa te bewaren.
- 5.4 Mosa is gerechtigd de zaken die onder eigendomsvoorbehoud zijn geleverd en nog bij de contractant aanwezig zijn terug te nemen indien de contractant in gebreke is met de nakoming van zijn betalingsverplichtingen of in betalingsmoeilijkheden verkeert of dreigt te gaan verkeren. De contractant dient Mosa (of een door Mosa aangewezen vertegenwoordiger) te allen tijde vrije toegang te verschaffen tot de terreinen en/of gebouwen ter inspectie van de zaken en/of ter uitoefening van haar rechten.
- 5.5 Voornoemde onder artikel 5.1 tot en met 5.4 opgenomen bepalingen laten de overige aan Mosa toekomende rechten onverlet.

6. Intellectuele eigendom

- 6.1 Alle intellectuele eigendomsrechten met betrekking tot de producten en de vormgeving daarvan, brochures en programmatuur van Mosa en zaken die Mosa bij uitvoering van de overeenkomst ontwikkelt en/of gebruikt, komen toe aan Mosa, voor zover deze niet reeds aan derden toekomen en tenzij schriftelijk anders is overeengekomen.
- 6.2 Het is de contractant niet toegestaan om enige aanduiding omtrent auteursrechten, merken, handelsnamen of andere rechten van intellectuele eigendom uit de producten, brochures en programmatuur en/of andere zaken van Mosa, te verwijderen en/of te wijzigen.
- 6.3 Indien een order uitgevoerd moet worden naar ontwerpen, tekeningen of andere aanwijzingen van de contractant, garandeert de contractant dat daardoor geen inbreuk op intellectuele eigendomsrechten of andere rechten van derden wordt gemaakt. De contractant vrijwaart Mosa voor alle aanspraken van derden wegens inbreuk op hun intellectuele eigendomsrechten, al dan niet strekkende tot schadevergoeding alsmede voor alle kosten die in verband daarmee voor Mosa ontstaan, inclusief kosten van rechtsbijstand.

7. Retourzendingen

7. Retourzendingen worden uitsluitend in ontvangst genomen indien de retourzending vooraf is goedgekeurd door Mosa en mits de goederen in goede staat en in de originele verpakking worden aangeboden. De retourzendingen die aan deze eisen voldoen, worden gecrediteerd tegen de oorspronkelijke aankoopprijs vermindert met 25% ter compensatie van de kosten van Mosa. De contractant dient de goederen op eigen kosten en voor eigen risico aan Mosa te retourneren. Indien tijdens het vervoer schade ontstaat, is Mosa niet gehouden de kooprijts te crediteren.

8. Klachten en vervaltermijn

- 8.1 Klachten dienen schriftelijk en rechtstreeks ter kennis van Mosa te worden gebracht, onder nauwkeurige opgave van de aard en omvang van de klachten. In geval van zichtbare gebreken dient zulks te geschieden overeenkomstig artikel 3.2. In geval van verborgen gebreken dient zulks tegeschieden binnen 14 dagen nadat het gebrek is vastgesteld, bij gebreke waarvan het recht op ontbinding van de overeenkomst, het recht tot het vorderen van nakoming en/of schadevergoeding vervalt.
- 8.2 Klachten over geleverde zaken worden niet in ontvangst genomen, indien aan de zaken be- en/of verwerkingswerkzaamheden zijn verricht nadat van enig gebrek is gebleken.
- 8.3 Afwijkingen in maat en tint welke binnen de gebruikelijke tolerantiesvallen geven geen recht tot reclame.
- 8.4 Mosa zal ten aanzien van alle klachten in de gelegenheid worden gesteld deze te controleren. Bij gegronde bevinding door Mosa heeft Mosa de keuze de zaken terug te nemen, te ruilen, een reductie op de prijs te geven of andere maatregelen te treffen. Indien Mosa of een geschilbeslechter bepaalt dat een klacht terecht is, zal Mosa uitsluitend naar keuze van Mosa de zaken terugnemen, ruilen, een reductie op de prijs geven of andere maatregelen treffen.
- 8.5 Indien de contractant niet binnen één jaar na levering door Mosa een vordering in rechte heeft ingesteld, vervalt het recht om in rechte ontbinding van de overeenkomst, het recht om nakoming en/of schadevergoeding te vorderen.

9. Overmacht

- 9.1 Tekortkomingen van Mosa in de nakoming van de overeenkomst als gevolg van overmacht, waaronder bijvoorbeeld een in ieder geval dient te worden verstaan: oorlog, mobilisatie, onlusten, overstroming, gesloten scheepvaart, strekkingen in het verkeer, stagnatie in resp. beperkingen of stopzetting van de levering door openbare nutsbedrijven, gebrek aan middelen tot energieopwekking, brand, instortingen, verzakkingen, explosies, machinebreuk en andere ongevallen, stakingen, uitsluitingen, acties van vakbonden, uitvoerbeperkingen, pandemie zoals COVID-19, blitseminslag, andere maatregelen van overheidswege, niet levering van noodzakelijke materialen (en/of halfabrikaten) en/of diensten die nodig zijn voor de productie, hetzij van overheidswege, hetzij door derden, opzet of grove schuld van hulpverleners en andere soortgelijke omstandigheden, worden in ieder geval aangemerkt als niet aan Mosa toe te rekenen, en geven de contractant dan ook geen recht tot ontbinding van de overeenkomst of tot schadevergoeding.
- 9.2 Indien Mosa, in afwijking van deze voorwaarden, met de contractant een fatale levertermijn is overeengekomen en Mosa wordt geconfronteerd met een tijdelijke overmacht, is Mosa gerechtigd de levertermijn met de duur van de overmachtsituatie te verlengen. Gedurende deze verlenging is derhalve geen sprake van een tekortkoming in de nakoming van Mosa, zodat de contractant geen vordering tot ontbinding dan wel schadevergoeding toekomt. Een fatale levertermijn kan in afwijking van deze Algemene voorwaarden alleen schriftelijk worden overeengekomen.

10. Garantie en aansprakelijkheid

- 10.1 Mosa garandeert dat zaken op het moment van levering voldoen aan de minimale Europese eisen voor prestatie en veiligheid. Tenzij anders aangegeven, garandeert Mosa dat zaken op het moment van levering geschikt zijn voor normaal gebruik en voor zover relevant aan de eigenschappen voldoen zoals opgenomen in het productblad bij een zaak. De beperkingen en voorschriften in deze algemene voorwaarden en de relevante productbladen bij een zaak gelden onvervoerd op deze garantie.
- 10.2 De aansprakelijkheid van Mosa voor schade die het gevolg is van haar toerekenbare tekortkomingen in de nakoming bij wege van vaststelling ex artikel 7:900 BW te bewijzen door contractant, is beperkt tot ten hoogste de factuurwaarde van de betreffende levering.
- 10.3 De aansprakelijkheid van Mosa voor schade veroorzaakt door fouten in haar ontwerpen en adviezen worden slechts aanvaard voor zover de ontwerpen en adviezen schriftelijk zijn verstrekt en het betreffende werk is uitgevoerd geheel overeenkomstig het ontwerp en advies en met het door Mosa voorgeschreven en geleverde materiaal onverlet het in artikel 10.1 bepaalde.
- 10.4 De in artikel 10.3 bedoelde aansprakelijkheid is beperkt tot ten hoogste de factuurwaarde van de door Mosa geadviseerde en geleverde materialen, die zijn verwerkt in dat gedeelte van een project waarop een eventuele fout in een ontwerp of advies betrekking heeft.
- 10.5 Mosa is niet aansprakelijk voor schade indien de zaken op onjuiste wijze worden be- en/of verwerkt, opgeslagen en/of vervoerd.
- 10.6 Mosa is niet aansprakelijk voor schade indien de zaken worden gebruikt voor een andere bestemming dan waarvoor zij op basis van door Mosa gegeven informatie geschikt zijn en - in ieder geval - normaliter gebruikt worden. haarscheurbestandheid. Haarscheuren in geglaazuurde tegels ontstaan door spanningsverschillen, vaak als gevolg van onjuiste verwerking. Mosa geeft geen enkele garantie voor het niet optreden van haarscheuren. Het optreden van haarscheuren na levering geeft daarom geen grond voor afkeuring of schadevergoeding.
- 10.10 Mosa is niet aansprakelijk voor de gevolgen van niet naleving door contractant van de Construction Product Regulation van de EU welke sinds 1 juli 2013 van kracht is. De contractant vrijwaart Mosa voor aansprakelijkheid jegens derden voor het door contractant in strijd handelen met de Construction Product Regulation.
- 10.11 De contractant vrijwaart Mosa voor aansprakelijkheid jegens derden.
- 10.12 In geen geval is Mosa gehouden tot vergoeding van bedrijfsschade, gevolgschade, omzetzetting of verminderde goodwill in het bedrijf of beroep van de contractant door welke oorzaak ook ontstaan, daaronder begrepen vertraging in de levertijd van zaken. Contractant garandeert deze bepaling ten opzichte van haar afnemers op te nemen. Mosa is gerechtigd zich op deze bepaling ook jegens derden te beroepen.
- 10.13 Iedere vordering op Mosa tot schadevergoeding vervalt na een periode van 1 jaar, te rekenen vanaf het moment dat de vordering is ontstaan.

11. Geschillen

- 11.1 Op de relatie/overeenkomst en daaruit (indirect voortvloeiende) rechtsbetrekkingen tussen Mosa en de contractant c.q. andere contracterende partijen is Nederlands recht van toepassing. De werking van elk internationaal verdrag ter zake van de koop van roerende lichamelijke zaken waarvan de werking tussen partijen kan worden uitgesloten, is niet van toepassing en wordt hierbij uitdrukkelijk uitgesloten. Meer in het bijzonder wordt de toepasselijkheid van het verdrag van de Verenigde Naties inzake Internationale Koopovereenkomsten betreffende Roerende Zaken (Weens Koopverdrag 1980) uitdrukkelijk uitgesloten.
- 11.2 Alle geschillen die ontstaan of voortvloeien uit een met Mosa gesloten overeenkomst, zullen uitsluitend worden berecht door de bevoegde rechter in het Arrondissement Limburg, Maastricht, Nederland.

Les Conditions Générales de vente, de livraison et de paiement de Koninklijke Mosa bv

1. Champ d'application des présentes conditions

- 1.1 A défaut de convention contraire expresse entre les parties, les présentes conditions s'appliquent à toutes les offres, livraisons et contrats exécutés par la société Koninklijke Mosa bv, ci-après dénommée "Mosa" et pour lesquelles Mosa est partie.
- 1.2 Les éventuelles conditions (d'achat) de la partie avec laquelle Mosa passe un contrat, ci-après dénommées le "contrat", ne s'appliquent pas, même s'il y est fait expressément référence par le contractant dans la correspondance et les pièces qui émanent de lui.
- 1.3 Les présentes Conditions Générales ont été déposées aux Pays-Bas auprès de la Chambre de Commerce et d'Industrie du Limbourg du Sud, à Maastricht, Pays-Bas sous le numéro 14600086.
2. Offres et prix
- 2.1 Tout ordre remis par le contractant est contraignant en ce qui le concerne, quelle que soit la façon dont il a été transmis par ce dernier. Il en va également de même si l'ordre a été remis par des agents, représentants ou autres intermédiaires, la charge de la preuve selon laquelle l'ordre n'est pas contraignant incombant au contractant, conformément à l'article 7:900 du Code Civil néerlandais.
- 2.2 Toutes les offres sont sans engagement pour Mosa. Les contrats ne seront effectifs que lorsque Mosa aura reçu la commande, l'aura confirmée par écrit ou aura commencé son exécution.
- 2.3 Les offres sont basées sur les informations fournies par le contractant concernant l'utilisation qu'il prévoit, ses besoins (d'exploitation) etc. Mosa est censé pouvoir se fier à leur exactitude.
- 2.4 Une offre est en tout cas censée avoir été rejetée si une commande basée sur cette offre n'a pas été renvoyée signée à Mosa dans les 6 semaines.
- 2.5 Les modifications apportées à l'offre doivent être communiquées à Mosa par écrit par le contractant. Ces modifications n'entrent en vigueur qu'après acceptation écrite par Mosa. Les éventuelles majorations ou diminutions de prix résultant des modifications acceptées par Mosa dans l'offre seront à charge ou en faveur du contractant. Les modifications apportées à l'ordre peuvent entraîner un dépassement des délais de livraison convenus. Mosa n'en sera nullement responsable, sans préjudice aux dispositions de l'article 3.3.
- 2.6 Les échantillons / exemplaires en guise d'essai seront toujours fournis à titre d'indication, sans que les marchandises doivent y correspondre. Il est interdit de commercialiser et / ou d'utiliser ou de consommer des échantillons / exemplaires fournis en guise d'essai.
- 2.7 Tous les prix s'entendent hors taxe sur la valeur ajoutée et sont FCA (Incoterms 2020) départ site (d'entreposage) Mosa, conformément aux tarifs établis par Mosa, en vigueur le jour de la livraison.
- 2.8 Si, pendant la période située entre, d'une part, la date de l'offre, respectivement l'établissement du contrat et, de l'autre, la date de la livraison, une augmentation d'un ou de plusieurs facteurs du prix de revient intervient, Mosa est en droit de majorer ses prix en conséquence, étant entendu que :
 - si la livraison des marchandises a lieu dans les 30 jours suivant l'établissement du contrat, les prix mentionnés dans le contrat resteront d'application ;
 - si, dans les 3 mois suivant la conclusion du contrat, une augmentation de prix intervient, le contractant est en droit de déclarer le contrat résilié pour la partie non encore exécutée. Cette résiliation peut uniquement avoir lieu par écrit. Dans pareil cas, le contractant n'a aucun droit à des dommages et intérêts.
- 2.9 Le contenu des brochures utilisé par Mosa, de ses imprimés, etc. ne l'engage nullement, à moins que cela soit mentionné expressément dans le contrat ou qu'il y soit fait expressément référence dans le contrat. Dans ce dernier cas, Mosa ne sera jamais tenu responsable des éventuelles erreurs d'impression et / ou de typographie.
3. Livraison
- 3.1 La livraison des marchandises par Mosa se fait FCA (Incoterms 2020) départ site (d'entreposage) Mosa. A compter de la livraison, le contractant en assume l'entier risque.
- 3.2 Le contractant est tenu de contrôler les marchandises lors de la livraison quant à la présence de vices visibles et également de vérifier la taille, la teinte, la sorte, le type et la quantité, selon le cas. Si le contractant réceptionne les marchandises sans formuler des remarques écrites, il est censé les avoir acceptées entièrement et sans réserves après 8 jours. Dans ce cas, les réclamations concernant les vices visibles ne seront pas traitées et le droit de résiliation du contrat, tout comme le droit à réclamer le respect des obligations et / ou des dommages et intérêts tombent.
- 3.3 Les délais et heures de livraison indiqués sont approximatifs et ne doivent pas être considérés comme des délais fatals. Le non-respect par Mosa des délais de livraison indiqués ne pourra pas être qualifié de manquement imputable à ce dernier et n'habilita nullement le contractant à résilier le contrat ou à annuler la commande. Il n'autorise pas non plus le contractant à réclamer des dommages et intérêts, sauf après expiration d'un délai de 3 mois à compter de la date de livraison convenue, suivi d'une mise en demeure envoyée par lettre recommandée ou par exploit d'huissier accordant à Mosa un délai raisonnable lui permettant de respecter ses obligations, respectivement d'exécuter la commande qui lui a été remise. Quoi qu'il en soit, le non-respect des délais de livraison ne sera jamais un motif justifiant l'octroi de quelconques dommages et intérêts. Si, à quelque moment que ce soit, la livraison (dans les temps) s'avère être impossible, Mosa devra en aviser le contractant le plus rapidement possible.
- 3.4 Le contractant est dans l'obligation d'enlever les marchandises achetées dans les délais convenus, à défaut de quoi Mosa est autorisé à en disposer selon son bon vouloir, sans préjudice à l'obligation du contractant d'en payer le prix d'achat.
- 3.5 Si des délais d'enlèvement n'ont pas été convenus, le contractant doit enlever les marchandises dans le mois suivant la date de livraison indiquée. Si la date de livraison indiquée ne peut réellement pas être respectée par Mosa, le contractant doit enlever les marchandises dans le mois suivant la date de livraison adaptée par Mosa, à défaut de quoi Mosa est autorisé à en disposer selon son bon vouloir, sans préjudice à l'obligation du contractant d'en payer le prix d'achat.
- 3.6 Le contractant devra aviser Mosa, au moins 24 heures avant l'enlèvement, par écrit, de la date à laquelle il viendra enlever les marchandises. S'il néglige de le faire, les frais (complémentaires) qui en découleraient éventuellement seront à sa charge.
- 3.7 Si le contractant souhaite que les marchandises soient transportées par Mosa et si Mosa marque son accord à ce propos, la règle reste que les marchandises sont fournies FCA (Incoterms 2020) départ site (d'entreposage) Mosa. Par conséquent, le risque afférent aux marches dites revient au contractant dès le moment de la livraison FCA (Incoterms 2010) départ site (d'entreposage) Mosa. En outre, le transport a lieu pour le compte et aux risques et périls du contractant. Le délai d'appel minimum pour le contractant est, dans ce cas, de 48 heures.
4. Paiement et garantie
- 4.1 La facturation a lieu simultanément à la livraison. Sauf autre accord, le contractant doit acquitter les factures dans les 30 jours suivant la date de facturation sans qu'une compensation, une suspension et / ou une réduction ne soient autorisées. Si le contractant paie dans les 10 jours suivant la date de facturation et si, par ailleurs, toutes les factures précédentes ont été acquittées par le contractant en temps opportun, Mosa accorde une réduction de paiement de l'ordre d'1%.
- 4.2 Si le montant facturé n'a pas été acquitté le jour de l'échéance, le contractant sera considéré comme étant en défaut du simple fait

de l'expiration des délais, sans qu'une mise en demeure ne soit requise. Dans ce cas, la créance à l'égard de Mosa sera majorée de plein droit d'un intérêt de retard de l'ordre d'1,5% par mois (ou par partie de mois) sur le montant facturé, T.V.A. incluse, à compter de l'échéance. Si l'intérêt commercial légal était supérieur pendant une période déterminée par rapport au pourcentage mentionné ci-dessus, Mosa est en droit de le porter en compte. Si le contractant est en défaut, il sera également redevable des frais d'encaissement, lesquels frais sont fixés à 15% du montant facturé, moyennant un minimum de EUR 115,-.

- 4.3 Les paiements effectués par le contractant sont toujours destinés premièrement à couvrir tous les frais dus, deuxièmement à régler tous les intérêts dus et troisièmement à acquitter les factures exigibles depuis la période la plus longue, même si le contractant mentionne que le paiement a trait à une facture ultérieure.
- 4.4 Pendant l'exécution du contrat, Mosa se réserve le droit de réclamer des acomptes.
- 4.5 Pendant l'exécution du contrat, Mosa est en droit de réclamer une garantie appropriée (c'est-à-dire une qui lui convient). Le contractant devra fournir cette garantie à la première demande de Mosa.
- 4.6 Toutes les créances à l'égard de Mosa deviennent directement exigibles si :
 - a. le contractant ne paie pas ou le fait tardivement ;
 - b. le contractant ne fournit pas des acomptes ou une garantie appropriée après une demande adressée à cet effet par Mosa telle que visée aux articles 4.4 et 4.5 ;
 - c. la faillite / l'assainissement des dettes du contractant est demandée ou en cas de figure juridique correspondante dans le pays du contractant ;
 - d. si une quelconque partie des biens ou des avoirs du contractant est saisie ou en cas de figure juridique correspondante dans le pays du contractant ;
 - e. le contractant demande la surseance de paiement et l'obtient ou en cas de figure juridique correspondante dans le pays du contractant ;
 - f. le contractant vend ou arrête son exploitation / entreprise, en tout ou en partie ou en cas de figure juridique correspondante dans le pays du contractant ;
 - g. des changements sont apportés au niveau du contrôle direct ou indirect au sein de la société du contractant ;
 - h. le contractant ne respecte pas ses obligations vis-à-vis de Mosa.
- 4.7 Dans les cas décrits à l'article 4.6, Mosa est en droit :
 - a. de suspendre ses obligations contractuelles jusqu'au moment où le contractant a rempli l'ensemble de ses obligations ;
 - b. d'annuler et / ou de résilier le contrat en tout ou en partie moyennant une simple communication, sans qu'une mise en demeure ou une intervention judiciaire ne soit requise et ce, sans préjudice au droit de Mosa de réclamer le respect des obligations et / ou des dommages et intérêts.
- 4.8 Mosa est en droit de compenser les créances du contractant au moyen d'une ou de plusieurs autres créances que le contractant a à l'égard de Mosa ou à l'égard d'une ou de plusieurs sociétés au sein du groupe auquel Mosa appartient.
- 4.9 Si Mosa a convenu avec le contractant que Mosa est en droit d'avoir recours à des prélèvements automatiques, le contractant n'est pas autorisé à contre-passer le montant prélevé automatiquement par Mosa en raison des livraisons faites par Mosa au contractant, sans avoir reçu au préalable le consentement écrit de Mosa.

5. Réserve de propriété

- 5.1 Toutes les marchandises fournies ou à fournir restent la propriété exclusive de Mosa jusqu'à acquittement complet de l'ensemble des créances que le contractant a ou aura à l'égard du contractant de Mosa, en ce compris, quoi qu'il en soit, les créances visées à l'article 3:92, alinéa 2, du Code Civil néerlandais.
- 5.2 Tant que le contractant n'aura pas acquitté l'ensemble de ses créances, il est expressément interdit au contractant d'aliéner les marchandises livrées ou de les (faire) traiter, autrement que dans le cadre de l'exploitation normale de son entreprise. Tant que les créances susmentionnées n'auront pas été acquittées à Mosa, le contractant n'est nullement en droit de grever les marchandises livrées. Le contractant garantit d'informer formellement tout tiers éventuel possédant des sûretés de l'existence du présent article 5.2. Le contractant s'engage, à la première demande de Mosa, de collaborer à l'établissement d'un droit de gage sur les créances que le contractant a ou aura concernant la livraison, dans le cadre de l'exploitation normale de son entreprise, des marchandises vendues à ses clients.
- 5.3 Le contractant est dans l'obligation de conserver les marchandises livrées et faisant l'objet d'une réserve de propriété avec le soin qu'il s'impose et en tant que propriété reconnaissable appartenant à Mosa.
- 5.4 Mosa est en droit de reprendre les marchandises fournies moyennant une réserve de propriété et encore présentes chez le contractant si le contractant néglige de respecter ses obligations de paiement ou éprouve ou risque d'éprouver des difficultés de paiement. Le contractant doit permettre librement l'accès, à tout moment, à Mosa (ou à un représentant désigné par Mosa) aux terrains et / ou aux bâtiments, afin que ce dernier puisse contrôler les marchandises et / ou d'exercer ses droits.
- 5.5 Les dispositions visées aux articles 5.1 à 5.4 inclus n'entravent en rien les autres droits revenant à Mosa.
6. Propriété intellectuelle
- 6.1 Tous les droits de propriété intellectuelle relatifs aux produits et à leur conception, aux brochures et à la programmation de Mosa, de même qu'aux biens que Mosa développe et / ou utilise dans le cadre de l'exécution du contrat reviennent à Mosa, pour autant qu'ils ne reviennent déjà pas à des tiers et à défaut de convention contraire écrite.
- 6.2 Il est interdit au contractant de supprimer et / ou de modifier toute indication concernant les droits d'auteurs, marques, marques de commerce ou autres droits de propriété intellectuelle des produits, brochures et de la programmation et / ou d'autres biens appartenant à Mosa.
- 6.3 Si une commande doit être exécutée sur la base de concepts, croquis ou autres indications du contractant, le contractant garantit que cela n'implique aucune violation des droits de propriété intellectuelle ou d'autres droits revenant à des tiers. Le contractant décharge Mosa de toute requête émanant de tiers pour cause de violation de leurs droits de propriété intellectuelle, que cette requête porte sur des dommages et intérêts ou non, ainsi que de tous les frais en découlant supportés par Mosa, y compris les frais d'assistance juridique.
7. Envois en retour Les envois en retour seront exclusivement réceptionnés si l'envoi en retour a préalablement été approuvé par Mosa et à condition que les marchandises soient présentées en bon état et dans leur emballage d'origine. Les envois en retour qui satisfont à ces exigences seront crédités sur la base du prix d'achat d'origine, déduction faite de 25% en guise de compensation pour les frais engagés par Mosa. Le contractant doit renvoyer les marchandises à Mosa à ses frais et à ses risques et périls. Si, durant le transport, les marchandises sont endommagées, Mosa n'est nullement dans l'obligation de créditer le prix d'achat.
8. Réclamations et délai de préemption
- 8.1 Les réclamations doivent être communiquées, par écrit et directement, à Mosa, moyennant indication précise de la nature et de l'ampleur des réclamations. En cas de vices visibles, la réclamation doit être adressée conformément à l'article 3.2. En cas

de vices cachés, la réclamation doit être adressée dans les 14 jours après constatation du vice, à défaut de quoi le droit à réclamer la résiliation du contrat et le droit à réclamer le respect des obligations et / ou des dommages et intérêts tombent.

- 8.2 Les réclamations relatives aux marchandises livrées ne seront plus reçues si les marchandises ont été traitées et / ou transformées après qu'un vice s'est avéré.
- 8.3 Les divergences en termes de mesure et de teinte conformes aux tolérances usuelles ne donnent aucun droit à une quelconque réclamation.
- 8.4 Concernant l'ensemble des réclamations, Mosa devra être en mesure de les contrôler. Si Mosa ou le tribunal compétent estime que la réclamation est fondée, il pourra, au choix exclusif, reprendre les marchandises, les échanger, accorder une réduction sur le prix ou prendre d'autres mesures.
- 8.5 Si le contractant n'a pas, dans l'année suivant la livraison par Mosa, intenté une action en justice, le droit à réclamer la résiliation en justice du contrat et le droit à réclamer le respect des obligations et / ou des dommages et intérêts tombent.
9. Cas de force majeure
- 9.1 Les manquements de Mosa concernant l'exécution du contrat et résultant d'un cas de force majeure, parmi lesquels il faut, par exemple et en tout cas, entendre, une guerre, une mobilisation, des troubles, une inondation, la fermeture d'une voie maritime, des entraves en matière de transport, une stagnation, des restrictions ou un arrêt des livraisons par les entreprises de services d'utilité publique, le manque de moyens de production d'énergie, un incendie, des écroulements, des affaissements, des explosions, une panne de machine et d'autres accidents, des grèves, exclusions, actions syndicales, des restrictions en matière d'exportation, une pandémie comme le COVID-19, un coup de foudre, d'autres mesures émanant des pouvoirs publics, la non-livraison des matériaux nécessaires (et / ou de produits semi-finis) et / ou de services nécessaires à la production, du chef soit des pouvoirs publics, soit de tiers, une faute intentionnelle ou grave des assistants et d'autres circonstances similaires seront en tout cas considérés comme n'étant pas imputables à Mosa et n'habilitent dès lors nullement le contractant à exercer son droit à réclamer la résiliation du contrat ou des dommages et intérêts.
- 9.2 Si, en dérogation à ces conditions, Mosa est convenu d'un délai de livraison fatal avec le contractant et que Mosa est confronté à un cas de force majeure temporaire, Mosa est en droit de prolonger les délais de livraison de la durée de la situation de force majeure. Durant cette prolongation, il ne sera dès lors nullement question d'un non-respect des obligations dans le chef de Mosa de sorte que le contractant ne bénéficie d'autre droit à réclamer la résiliation du contrat ou des dommages et intérêts. Un délai fatal, en dérogation aux présentes Conditions Générales, pourra uniquement être convenu par écrit.
10. Garantie et responsabilité
- 10.1 Mosa garantit que les produits distribués sont conformes aux normes de la CE en matière de performance et de sécurité. Sauf indication contraire, Mosa garantit que les produits livrés sont appropriés pour une utilisation normale et, dans la mesure où cela est applicable, sont en conformité avec les spécifications telles qu'indiquées dans la fiche produit. Les restrictions et réglementations telles qu'incluses dans les présentes conditions générales et la fiche produit d'un bien s'appliquent intégralement à la présente garantie. La responsabilité de Mosa pour des dommages résultant de managements qui lui sont imputables, à prouver par le contractant conformément à l'article 7:900 du Code Civil néerlandais, est limitée à maximum la valeur facturée pour la livraison correspondante.
- 10.2 La responsabilité de Mosa pour des dommages provoqués par des erreurs dans ses concepts et avis ne sera acceptée que dans la mesure où les concepts et avis ont été communiqués par écrit et où le travail correspondant a été entièrement réalisé conformément à ces concepts et avis et au moyen des matériels prescrits et fournis par Mosa.
- 10.3 La responsabilité visée à l'article 10.3 se limite à maximum la valeur facturée pour les matériaux conseillés et livrés par Mosa et ayant été mis en oeuvre dans cette partie d'un projet auquel une erreur éventuelle au niveau du concept ou de l'avis a trait.
- 10.4 Mosa ne sera nullement tenu responsable des dommages résultant d'un traitement et / ou d'une transformation inappropriés des marchandises ou quand les marchandises sont stockés ou transportés de manière inadéquate.
- 10.5 Mosa ne sera nullement tenu responsable si les marchandises sont utilisées pour une destination autre que celle qui est appropriée sur la base des informations fournies par Mosa et qui - en tout cas - est normalement utilisée.
- 10.6 Mosa ne sera nullement tenu responsable des dommages résultant de propriétés non-fonctionnelles des marchandises et concernant les divergences en termes de taille et de teinte conformes aux tolérances usuelles.
- 10.7 Mosa ne sera nullement tenu responsable des dommages ou de la perte de marchandises appartenant au contractant ou à des tiers et mises à sa disposition en vue de la préparation et / ou de l'exécution du contrat.
- 10.8 Les carreaux en provenance de Mosa satisfont aux normes européennes en vigueur en matière de résistance aux fissures capillaires. Les fissures capillaires dans les carreaux émaillés résultent de différences de tension, souvent suite à une mise en oeuvre inappropriée. Mosa n'accorde aucune garantie concernant la non-survenance de fissures capillaires. La survenance de fissures capillaires après livraison ne donnera dès lors nullement lieu à un refus des marchandises ou à des dommages et intérêts.
- 10.9 Mosa n'est pas responsable des conséquences d'un non-respect par le contractant du Règlement de l'UE afférent aux produits de construction (Construction Product Regulation) et qui est en vigueur depuis le 1er juillet 2013. Le contractant garantit Mosa de tout recours de tiers au titre d'agissements du contractant contraires audit Règlement de l'UE.
- 10.10 Le contractant décharge Mosa de toute responsabilité vis-à-vis de tiers.
- 10.11 Mosa ne sera en aucun cas tenu à l'indemnisation des dommages d'exploitation, des dommages consécutifs, de la perte de bénéfices ou de la réduction du Goodwill au niveau de l'entreprise ou en ce qui concerne la profession du contractant quelle qu'en soit la cause, en ce compris les retards en termes de délais de livraison des marchandises. Mosa garantit la reprise de cette disposition eu égard à ses clients. Mosa est en droit d'invoquer également cette disposition vis-à-vis de tiers.
- 10.12 Toute requête à l'encontre de Mosa pour des dommages et intérêts échoit après une période d'une année, à compter du moment de la création de la créance.
11. Litiges
- 11.1 Le droit néerlandais s'applique aux relations / contrats, de même qu'aux relations juridiques (in)directes qui en découlent entre Mosa et le contractant ou d'autres parties contractantes. L'application de toute convention internationale en matière de vente de biens matériels mobiliers dont l'application peut être exclue entre les parties ne s'applique pas et est expressément exclue par les présentes Conditions Générales. Plus particulièrement, l'applicabilité de la convention des Nations Unies concernant les Contrats d'Achat relatifs à des Biens Mobiliers (Convention d'Achat de Vienne de 1980) est expressément exclue.
- 11.2 Tous les litiges créés par ou résultant d'un contrat conclu avec Mosa seront exclusivement tranchés par le juge compétent de l'arrondissement de Maastricht, Limburg (Pays-Bas).

General Conditions of Sales, Delivery and Payment of Koninklijke Mosa bv

1. Applicability of these Terms and Conditions

1.1 These Terms and Conditions shall apply to all offers and deliveries made by Koninklijke Mosa bv, further referred to as "Mosa", and to all agreements to which Mosa is a party, unless the Parties have expressly agreed otherwise in writing.

1.2 The terms and conditions, including terms and conditions of sales, of the party with whom Mosa enters into a contract, further referred to as the "contracting party", shall not apply even if the contracting party expressly refers to such terms and conditions in its correspondence and documents.

1.3 These General Terms and Conditions have been filed in Dutch with the Chamber of Commerce and Industry for South Limburg in Maastricht, The Netherlands, under number 14600086.

2. Offers and prices

2.1 An order given by the contracting party shall be binding on the contracting party, regardless of the manner in which the contracting party gave such order. This shall also apply if the order was given by agents, representatives or other intermediaries. The burden of proof that the order is found to not be binding lies with the contracting party, pursuant to article 7:900 of the Netherlands Civil Code.

2.2 All offers/quotations shall be without any obligation for Mosa. Agreements shall be formed only when Mosa, after it has received the order, confirms the order in writing, or has started to carry out the order. Offers/quotations shall be based on the information supplied by the contracting party with regard to its anticipated use and its (corporate) requirements etc., and it shall always be deemed that Mosa can assume such information to be correct.

2.4 An offer/quotation shall in any case be deemed to have been rejected if an order based on this offer/quotation has not been signed and returned to Mosa within six weeks.

2.5 The contracting party must notify Mosa in writing of changes to the order. Changes to the order shall take effect only after Mosa has accepted such changes in writing. Any additional or decreased costs resulting from changes to the order accepted by Mosa shall be payable by or credited to, the contracting party. Changes to the order may cause the agreed delivery period to be exceeded. Mosa shall not be liable for this in any way, notwithstanding the provisions of Article 3.3.

2.6 Samples/specimen copies shall always be provided as an indication, and the goods do not have to conform to such samples/specimen copies. It shall be prohibited to sell and/or use or consume such samples/specimen copies.

2.7 All prices shall be exclusive of turnover tax and shall be FCA (free carrier, Incoterms 2010) at the Mosa site/storage location, in accordance with the price lists drawn up by Mosa, valid on the day of delivery.

2.8 If during the period between the date of quotation or formation of the Agreement and the date of delivery, there is an increase in one or more cost price factors, Mosa shall be entitled to increase its prices accordingly, provided that:

- if the goods are delivered within thirty days of the Agreement being formed, the prices mentioned in the Agreement remain unchanged;

- if there is a price increase within three months of the Agreement being concluded, the contracting party shall be entitled to dissolve the Agreement for the part which has still to be carried out, within eight days of notification of the price increase being sent, which dissolution may take place only in writing. The contracting party shall in that case have no right to compensation.

2.9 The contents of Mosa's brochures and its printed matter etc. shall not be binding on Mosa unless this has been expressly stipulated in the Agreement or reference is expressly made thereto in the Agreement. In the latter case, Mosa shall never be bound by any printing errors and/or misprints.

3. Delivery

3.1 Mosa shall deliver the goods FCA (free carrier, Incoterms 2010) at the Mosa site/storage location. From the time of delivery, the goods shall be at the contracting party's expense and risk.

3.2 The contracting party must inspect the goods for visible defects at the time of delivery, and must also check the goods for size, shade, sort, type and quantity, all insofar as applicable. If the contracting party takes possession of the goods and does not make any written criticisms or observations within eight days, the contracting party is deemed to have accepted the goods completely and without reservation. Complaints relating to visible defects shall in that case not be accepted and the right to dissolve the Agreement and the right to claim performance and/or compensation shall lapse.

3.3 The delivery periods and times stated shall be approximate and shall not be regarded as deadlines. If the delivery times stated by Mosa are not met, this may not be deemed to be an attributable failure on the part of Mosa, and shall not give the contracting party the right to dissolve the Agreement or to cancel the order, nor shall it constitute grounds for compensation, except on the expiry of a period of three months counting from the delivery time agreed upon, followed by a notice of default sent by registered letter or bailiff's notification, which grants Mosa a reasonable period to still fulfil its delivery obligation, or to still carry out the order given. In any case, the exceeding of delivery times shall never constitute grounds for compensation. If at any time (timely) delivery proves impossible, Mosa shall make this known as quickly as possible.

3.4 The contracting party must take possession of the goods purchased within the agreed period. If it fails to do so, Mosa shall be free, at its own discretion, to dispose of the goods, without prejudice to the contracting party's obligation to pay the purchase price.

3.5 If no period was agreed upon for taking possession of the goods, the contracting party must take possession of the goods within one month of the delivery time stated. In the unlikely event that Mosa is unable to meet the delivery time stated, the contracting party must take possession of the goods within one month of the delivery time adjusted by Mosa. If the contracting party fails to do so, Mosa shall be free, at its own discretion, to dispose of the goods, without prejudice to the contracting party's obligation to pay the purchase price.

3.6 The contracting party shall notify Mosa in writing of when it intends to collect the goods at least 24 hours before taking possession of the goods. If it fails to do so, any (additional) costs arising therefrom shall be payable by the contracting party.

3.7 If the contracting party wishes to have the goods transported by Mosa, and Mosa agrees to do so, then this shall be without prejudice to the fact that the goods are delivered FCA (free carrier, Incoterms 2010) at the Mosa site/storage location. The goods shall therefore be at the contracting party's risk from the time of delivery FCA (free carrier, Incoterms 2010) at the Mosa site/storage location. Furthermore, the goods shall be transported at the contracting party's expense and risk. The minimum call period for the contracting party shall in that case be 48 hours.

4. Payment and security

4.1 Invoices shall be issued at the same time as delivery. Unless otherwise agreed, the contracting party must pay invoices within thirty days of the invoice date, without setoff, deferment and/or discount being permitted. If the contracting party pays within ten days of the invoice date, and all previous invoices have also been paid on time by the contracting party, a payment discount of 1% shall be granted by Mosa.

4.2 If the invoice amount has not been paid on the due date, the contracting party shall be in default by the mere expiry of that period, without any notice of default being required. In that case, Mosa's

claim shall be increased by operation of law by default interest at the rate of 1.5% per month (or part thereof) on the invoice value including turnover tax, calculated from the due date. If the statutory commercial interest over a particular period should be higher than the aforementioned percentage, Mosa shall have the right to charge the statutory commercial rate of interest. If the contracting party is in default, it must also pay collection costs, which shall be fixed at 15% of the invoice amount, with a minimum of EUR 115.-.

4.3 Payments made by the contracting party shall always serve to settle firstly all costs payable, secondly all interest payable, and thirdly those invoices which have been outstanding the longest, even if the contracting party states that a payment relates to a later invoice.

4.4 Mosa reserves the right to require advance payment during the performance of the Agreement.

4.5 During the performance of the Agreement, Mosa may require suitable (which means convenient for Mosa) security. At Mosa's first request, the contracting party must furnish this security.

4.6 All of Mosa's claims shall be due and payable as a lump sum immediately if:

a. the contracting party fails to pay or fails to pay in time;

b. the contracting party fails to make an advance payment or furnish suitable security after a request to that effect from Mosa, as referred to in Articles 4.4 and 4.5;

c. a petition is filed for the contracting party's liquidation or an application is filed for debt rescheduling in respect of the contracting party, or a legal concept in the contracting party's country considered equivalent thereto applies;

d. any part of the contracting party's property or assets is attached, or a legal concept in the contracting party's country considered equivalent thereto applies;

e. the contracting party applies for, or is granted, a moratorium on payments, or a legal concept in the contracting party's country considered equivalent thereto applies;

f. the contracting party sells or discontinues all or part of its business/ company, or a legal concept in the contracting party's country considered equivalent thereto applies;

g. the direct or indirect control within the contracting party's organization changes;

h. the contracting party fails to fulfil its obligations vis-à-vis Mosa.

4.7 In the cases described in Article 4.6, Mosa shall have the right:

a. to suspend performance of its contractual obligations until the contracting party has fulfilled its obligations in full;

b. to cancel and/or dissolve all or part of the Agreement by means of a simple statement, without notice of default or judicial intervention being required, and without prejudice to Mosa's right to performance and/or compensation.

4.8 Mosa shall be entitled to offset the contracting party's claims against one or more claims which the contracting party has at any time against Mosa or against one or more companies within the concern to which Mosa belongs.

4.9 If Mosa has agreed with the contracting party that Mosa may make use of direct debits, the contracting party is not permitted to reverse a direct debit payment collected automatically by Mosa pursuant to deliveries made to the contracting party without prior permission in writing from Mosa.

5. Retention of title

5.1 All goods delivered or still to be delivered shall remain the sole property of Mosa until all claims which Mosa has or shall obtain against the contracting party, including in any case the claims referred to in Section 3:92 paragraph 2 of the Netherlands Civil Code, have been paid in full.

5.2 As long as the contracting party has not paid the claims in full, the contracting party shall expressly be prohibited from disposing of or processing (or having processed) the goods delivered, other than within the context of its normal business activities. As long as the aforementioned claims have not been paid to Mosa in full, the contracting party shall not be entitled to encumber the goods delivered. The contracting party guarantees that it will explicitly inform any third parties with security interests of the contents of this article 5.2. The contracting party undertakes, at Mosa's first request, to cooperate in the establishment of a right of pledge in respect of claims which the contracting party obtains or shall obtain against its customers as a result of its reselling goods within the context of its normal business activities.

5.3 The contracting party must keep the goods which are delivered subject to a retention of title with due care and as the recognizable property of Mosa.

5.4 Mosa shall be entitled to take back the goods which are delivered subject to a retention of title and which are still available to the contracting party if the contracting party fails to fulfil its payment obligations or is experiencing financial difficulties, or there is a risk that it shall experience financial difficulties. The contracting party must grant Mosa (or a representative appointed by Mosa) free access at all times to its grounds and/or buildings for the purposes of inspecting the goods and/or exercising its rights.

5.5 The stipulations contained within Articles 5.1 to 5.4 inclusive shall not affect Mosa's other rights.

6. Intellectual property

6.1 All intellectual property rights relating to Mosa's products and their design, its brochures and software, and to goods which Mosa develops and/or uses during the performance of the Agreement, shall belong to Mosa, insofar as they do not already belong to third parties, and unless agreed otherwise in writing.

6.2 The contracting party shall not be permitted to remove or change any indications about copyright, trademarks, trade names and/or other intellectual property rights on the products, brochures, software and/or other goods belonging to Mosa.

6.3 If an order must be carried out according to the contracting party's designs, drawings or other instructions, the contracting party shall guarantee that this shall not entail any infringement of intellectual property rights or other third-party rights. The contracting party shall indemnify Mosa against all third-party claims on account of an infringement of their intellectual property rights, whether or not such claims are for compensation, and shall also indemnify Mosa against all costs which Mosa incurs in connection with third-party claims, including the costs of legal assistance.

7. Goods returned

Goods returned shall be accepted only if their return was approved in advance by Mosa, and provided that the goods are offered in good condition and in their original packaging. Goods returned which meet these requirements shall be credited at the original purchase price less 25% as compensation for costs incurred by Mosa. The contracting party must return the goods to Mosa at its own expense and risk. If damage arises during transportation, Mosa shall not be obliged to credit the purchase price.

8. Complaints and expiry period

8.1 Complaints must be notified to Mosa directly and in writing, stating the precise nature and extent of the complaints. In the case of visible defects, complaints must be submitted in accordance with Article 3.2. In the case of hidden defects, complaints must be submitted within 14 days of the defect being discovered, failing which the right to dissolve the Agreement and the right to claim performance and/or compensation shall expire.

8.2 Complaints about goods delivered shall not be accepted if the goods

have been treated and/or processed after any defect has become manifest.

8.3 Deviations in size and shade which fall within the usual tolerances shall give no right to complaint.

8.4 With respect to all complaints, Mosa shall be given the opportunity to check such complaints. If the complaint is found to be valid by Mosa, Mosa shall have the choice of taking back the goods, exchanging the goods, giving a price reduction or taking other steps.

8.5 If the contracting party has not instituted a claim at law within one year of delivery by Mosa, the right to claim dissolution of the Agreement at law and the right to claim performance and/or compensation shall lapse.

9. Force majeure

9.1 Failures on the part of Mosa in its performance of the Agreement as a result of force majeure, including for example and understood to mean: war, mobilization, civil commotion, flood, closed shipping, transport gridlocks, delays, restrictions or the halt in the supply by public utility companies, lack of means of generating energy, fire, cave-ins/collapse, subsidence, explosions, machine breakdowns and other accidents, strike action, lockouts, trade union action, export restrictions, pandemics, lightning strikes, other government measures, non-delivery of necessary materials (and/or semi-finished goods) and/or services which are necessary for the production, either by the government or by third parties, intentional act or gross negligence on the part of auxiliary persons, and other similar circumstances, shall in any case be regarded as not attributable to Mosa, and shall therefore give the contracting party no right to dissolve the Agreement or claim compensation.

9.2 If, contrary to these Terms and Conditions, Mosa has agreed upon a strict delivery deadline with the contracting party, and Mosa is faced with temporary force majeure, Mosa shall be entitled to extend the delivery period by the duration of the force majeure situation. This extension shall therefore not constitute any failure in Mosa's performance, and the contracting party shall have no right to claim dissolution or compensation. Contrary to these General Terms and Conditions, a strict delivery period may be agreed upon only in writing.

10. Warranty and liability

10.1 Mosa warrants delivered goods shall be in conformity with CE standards regarding performance and safety. Unless otherwise specified, Mosa warrants delivered goods are suitable for normal use and, insofar relevant, are in accordance with the specifications as included in the product sheet. The restrictions and regulations as included in these general terms and conditions and the product sheet of a good apply in full to this warranty.

10.2 Mosa's liability for damage resulting from its attributable failure to perform, to be ascertained by means of proof provided by the contracting party pursuant to article 7:900 of the Netherlands Civil Code, shall be limited to a maximum of the invoice value for the delivery concerned.

10.3 Mosa's liability for damage caused by faults in its designs and advice in its advice, shall be accepted only insofar as the designs and advice were supplied in writing and the work concerned was carried out entirely in accordance with the design and advice and using the material prescribed and supplied by Mosa.

10.4 The liability referred to in Article 10.3 shall be limited to a maximum of the invoice value of the materials recommended and supplied by Mosa, which were processed in that part of a project to which any design fault or error in advice relates.

10.5 Mosa shall not be liable for damage if the goods are treated, processed, stored or transported incorrectly.

10.6 Mosa shall not be liable for damage if the goods are used for a purpose other than the purpose for which they are suitable based on the information given by Mosa, and in any case the purpose for which they are normally used.

10.7 Mosa shall not be liable for damage resulting from non-functional properties of the goods and relating to deviations in size and shade which fall within the usual tolerances.

10.8 Mosa shall not be liable for damage to, or loss of, goods belonging to the contracting party or third parties, which are made available to it in connection with the preparation and/or performance of the Agreement.

10.9 The tiles from Mosa comply with European standards on hairline crack resistance. Hairline cracks in glazed tiles are caused by stress differences, often resulting from incorrect processing. Mosa gives no guarantee whatsoever for the non-appearance of hairline cracks. The appearance of hairline cracks after delivery shall therefore constitute no grounds for rejection or compensation.

10.10 Mosa is not liable for the consequences of the contracting party's failure to comply with the EU Construction Product Regulation, which entered into effect on 1 July 2013. The contracting party indemnifies Mosa against any third-party liability the contracting party incurs through any contravention of the Construction Product Regulation.

10.11 The contracting party shall indemnify Mosa against liability towards third parties.

10.12 Under no circumstances shall Mosa be obliged to compensate for trading loss, consequential damage, loss of sales or decreased goodwill in the contracting party's business or profession however caused, including delays in the delivery of goods. The contracting party guarantees the application of this provision with respect to its buyers. Mosa is entitled to invoke this provision vis-à-vis third parties.

10.13 Any claim against Mosa for compensation shall lapse after a period of one year, calculated from the time that the claim arose.

11. Disputes

11.1 Dutch law shall apply to the relationship/agreement and to the legal relationships arising (in)directly therefrom between Mosa and the contracting party and/or other contracting parties. The effect of any international treaty concerning the purchase of moveable goods, whose effect may be ruled out between the Parties, shall not apply and is hereby expressly ruled out. In particular, the applicability of the United Nations Convention on Contracts for the International Sale of Goods (Vienna Sales Convention 1980) is expressly ruled out.

11.2 All disputes arising from an Agreement concluded with Mosa shall be adjudicated exclusively by the competent court in the district of Limburg in The Netherlands.

